



# A/C COMPRESSOR

- **SPARE PARTS FOR THE COMPRESSORS**  
Części zamienne do sprężarek klimatyzacji

- **NEW AND REBUILD COMPRESSORS**  
Nowe i regenerowane kompresory

- **PROFESSIONAL REBUILDER**  
Profesjonalna regeneracja



2018  
V.01



[WWW.ACAUTO.PL](http://WWW.ACAUTO.PL)



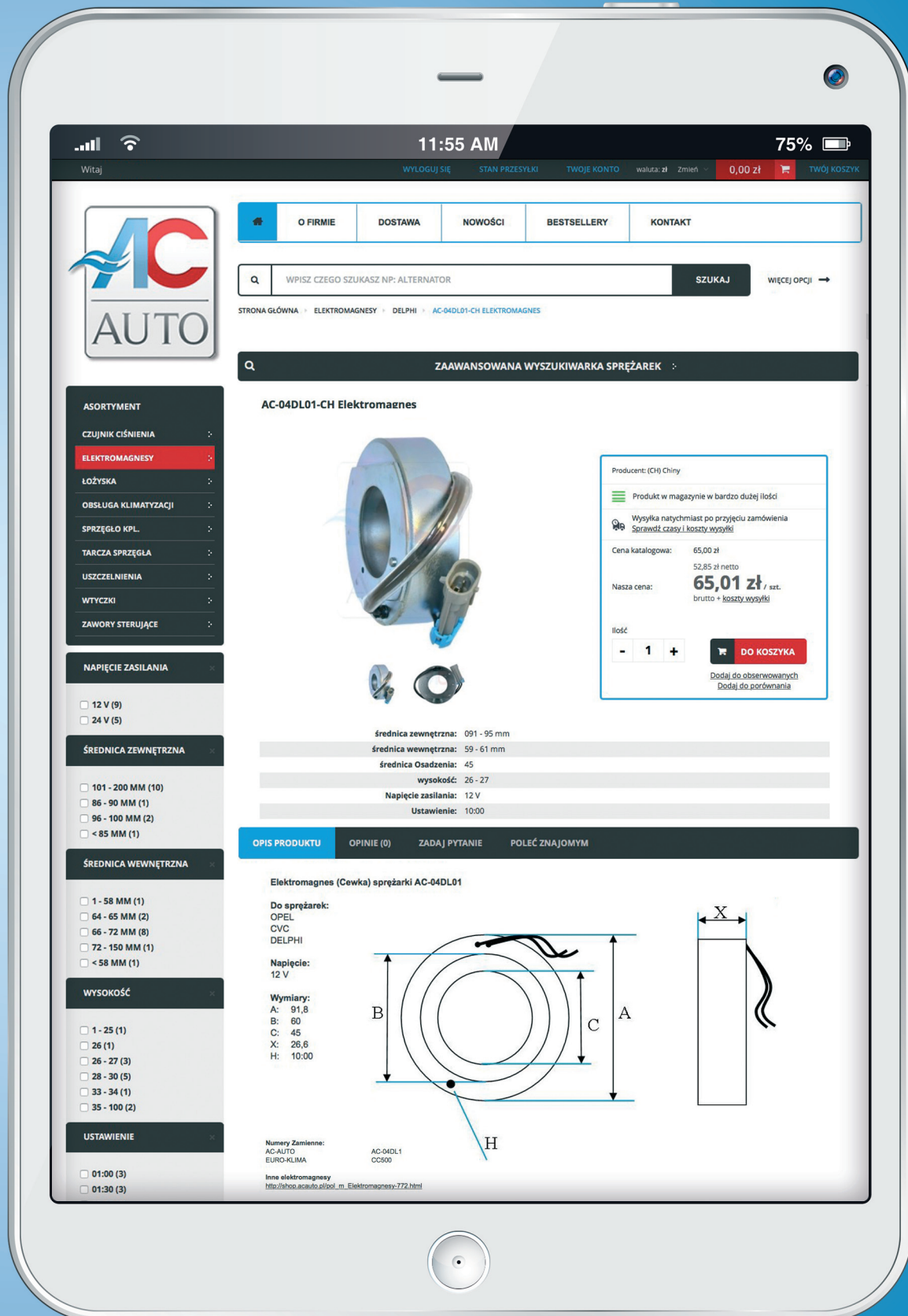





# SHOP.ACAUTO.PL



## Table of contents / Spis treści:

Control Valves / Zawóry sterujące .....	2
Bearings / Łożyska .....	6
Clutch coils / Elektromagnesy.....	7
Clutch coils (technical informations) / Elektromagnesy (techniczne informacje).....	15
Clutch hubs / Tarcze sprzęgieł .....	17
Clutch hubs (technical informations) / Tarcze sprzęgieł (techniczne informacje) .....	24
Clutch assemblies / Sprzęgła kompletne .....	26
Clutch assemblies (technical informations) / Sprzęgła kompletne (techniczne informacje) ...	45
Plugs / Wtyczki .....	46
AC Service and parts / Obsługa klimatyzacji.....	48
Pressure switches / Czujniki ciśnienia .....	50
Shaft Seals / Uszczelnienia Czołowe .....	52
Gasket Seals / Uszczelnienia Boczne .....	54
Shaft Seals (technical informations)/ Uszczelnienia Czołowe (techniczne informacje) .....	59
Compressor brackets / Obudowy kompresorów .....	60

## Symbols / Symbole:

-  Compressor type / Symbol kompresora
-  Diameter / Średnica
-  Number of grooves / Ilość rowków koła
- H: Fixing point clock of pin on coil / Godzina ustalająca bolec mocujący na elektromagnesie
-  Bearing / Łożysko
-  Clutch coil / Elektromagnes sprzęgła
-  Clutch hub / Tarcza sprzęgła
-  Clutch coil voltage / Woltaż elektromagnesu
-  Length of control valve / Długość zaworu sterującego



<p><b>CALSONIC</b> <b>2CL01</b></p>  <p>93 mm CWE618</p> <p><b>NISSAN</b></p>	<p><b>CALSONIC</b> <b>2CL02</b></p>  <p>69 mm V6</p> <p><b>BMW</b></p>	<p><b>CALSONIC</b> <b>2CL03</b></p>  <p>96 mm</p> <p><b>BMW E90</b></p>
<p><b>DELPHI</b> <b>2DL01</b></p>  <p>86 mm V5</p> <p><b>RENAULT</b></p>	<p><b>DELPHI</b> <b>2DL02.G</b></p>  <p>68 mm V5</p>	<p><b>DELPHI</b> <b>2DL02.R</b></p>  <p>69 mm V5</p>
<p><b>DELPHI</b> <b>2DL02.Y</b></p>  <p>68 mm V5</p>	<p><b>DELPHI</b> <b>2DL03</b></p>  <p>88 mm CVC</p> <p><b>VW</b></p>	<p><b>DELPHI</b> <b>2DL04</b></p>  <p>88 mm CVC</p> <p><b>OPEL</b></p>
<p><b>DELPHI</b> <b>2DL05</b></p>  <p>88 mm CVC</p> <p><b>OPEL</b></p>	<p><b>DELPHI</b> <b>2DL06</b></p>  <p>88 mm 5 CVC</p> <p><b>FIAT/ALFA ROMEO/LANCIA</b></p>	<p><b>DELPHI</b> <b>2DL07</b></p>  <p>87 mm CVC</p> <p><b>AUDI/SKODA /VW</b></p>
<p><b>DELPHI</b> <b>2DL08</b></p>  <p>89 mm CVC</p> <p><b>OPEL</b></p>	<p><b>DELPHI</b> <b>2DL09</b></p>  <p>79,5 mm CVC</p> <p><b>AUDI/SKODA /VW</b></p>	<p><b>DELPHI</b> <b>2DL10</b></p>  <p>80 mm</p> <p><b>OPEL</b></p>
<p><b>DENSO</b> <b>2DN01</b></p>  <p>71 mm 5SL12C</p> <p><b>FIAT/OPEL</b></p>	<p><b>DENSO</b> <b>2DN02</b></p>  <p>92 mm 6SEU12/ 6SEU16/ 7SEU16</p> <p><b>AUDI/SEAT/SKODA/VW</b></p>	<p><b>DENSO</b> <b>2DN03.Y</b></p>  <p>94 mm 6SEU/ 6SEU16/ 7SEU16</p> <p><b>MERCEDES/BMW</b></p>
<p><b>DENSO</b> <b>2DN03.B</b></p>  <p>94 mm 6SEU/ 6SEU16/ 7SEU16</p> <p><b>VW</b></p>	<p><b>DENSO</b> <b>2DN04</b></p>  <p>97 mm 5SE09C/ 5SE12C</p> <p><b>TOYOTA</b></p>	<p><b>DENSO</b> <b>2DN05</b></p>  <p>93 mm 6SEU/ 6SEU16/ 7SEU16</p> <p><b>AUDI/SEAT/SKODA/VW</b></p>



**DENSO** **2DN06**



93 mm  
6SEU16/  
7SEU16

MERCEDES/BMW

**DENSO** **2DN07**



123 mm  
6SEU12C/  
6SEU16C

TOYOTA

**DENSO** **2DN08**



96 mm  
6SEU12C/  
6SEU16C

AUDI/SEAT/SKODA/VW

**DENSO** **2DN09**



89 mm  
6SE/7SE

BMW

**DENSO** **2DN10**



50 mm  
7SB/7SBU

**DENSO** **2DN11**



51,5 mm  
5SE12

FIAT/OPEL

**DENSO** **2DN12**



57,5 mm  
6C17/  
6CA17C/  
7SB16C

**DENSO** **2DN13**



94 mm  
7SEU17C

**DENSO** **2DN14**



97 mm

**DENSO** **2DN15**



93 mm

CITROEN/PEUGEOT

**DENSO** **2DN16**



96 mm  
5SER09

TOYOTA

**DENSO** **2DN17**



98 mm

TOYOTA

**DENSO** **2DN18**



92 mm

TOYOTA

**DENSO** **2DN20**



86 mm  
5SE/6SE

AUDI/SEAT/SKODA/VW

**DENSO** **2DN21**



65 mm  
7SBU16H

LEXUS

**DENSO** **2DN22**



87 mm

AUDI/ BMW/MERCEDES

**DENSO** **2DN23**



99 mm  
5SE/6SE

CITROEN/PEUGEOT

**DENSO** **2DN24**



103 mm

CITROEN/PEUGEOT

**DENSO** **2DN25**



95 mm  
5SE/6SE/  
7SE

BMW

**DENSO** **2DN27** *NEW!!! v.01*



TSB10C  
SPEED  
SENSOR

TOYOTA

**HALLA** **2HA01**



94 mm  
VS16E/  
VS18E

HYUNDAI

**HALLA** **2HA02**  
  
 97 mm  
**HYUNDAI**

**SCROLL** **2SC01**  
  
 33 mm  
**FORD**

**SANDEN** **2SD01**  
  
 53 mm  
 SD6V12/  
 SD7V16  
**FORD**

**SANDEN** **2SD02**  
  
 103 mm  
 PXE  
**AUDI/SEAT/SKODA/VW**

**SANDEN** **2SD03**  
  
 72 mm  
 PXE  
**AUDI/SEAT/SKODA/VW**

**SANDEN** **2SD04**  
  
 96 mm  
 6C16/7C16  
**CITROEN/PEUGEOT**

**SANDEN** **2SD05**  
  
 101 mm  
 PXE  
**AUDI/SEAT/SKODA/VW**

**SANDEN** **2SD06**  
  
 103 mm  
 7C16  
**CITROEN/PEUGEOT**

**SANDEN** **2SD07**  
  
 78 mm  
 PXE  
**AUDI/SEAT/SKODA/VW**

**SANDEN** **2SD08**  
  
 72 mm  
 PXE16  
**AUDI/SEAT/SKODA/VW**

**SANDEN** **2SD09**  
  
 88 mm  
 PXE16  
**OPEL**

**SANDEN** **2SD10**  
  
 78 mm  
 PXE14  
**AUDI/SEAT/SKODA/VW**

**SANDEN** **2SD11**  
  
 42 mm  
 PXE16  
**FORD**

**SANDEN** **2SD12**  
  
 88 mm  
 PXE14  
**NISSAN**

**SANDEN** **2SD13**  
  
 44 mm  
 SD7V16/  
 SD6V12  
**FORD/ VW**

**VISTEON** **2VI01**  
  
 54 mm  
 VS16  
**FORD**

**VISTEON** **2VI02**  
  
 87 mm  
**FORD/ VOLVO**

**VISTEON** **2VI03**  
  
 55 mm  
**FORD/ VOLVO**

**VISTEON** **2VI04**  
  
 94 mm  
 VS16E/  
 VS18E  
**FORD**

**ZEXEL** **2ZX01**  
  
 97 mm  
 DCS17E/  
 DCW17F  
**AUDI/SEAT/SKODA/VW**

**ZEXEL** **2ZX02**  
  
 97 mm  
 DCS17/  
 KC-88  
**MERCEDES**

ZEXEL **2ZX03**



44 mm  
DCW-17C

AUDI/VW

ZEXEL **2ZX04**



103 mm

NISSAN/OPEL/RENAULT

ZEXEL **2ZX05**



38 mm  
DKV-10R

SUBARU

ZEXEL **2ZX06**



86 mm  
DCS17E

FORD/VOLVO

ZEXEL **2ZX07**



94 mm  
DCS17E

MERCEDES

ZEXEL **2ZX08**



87 mm  
DCS17E

HYUNDAI/ VW

ZEXEL **2ZX09** *NEW!!! v.01*



86 mm  
VS16E/  
VS18E

HYUNDAI

ZEXEL **2ZX10** *NEW!!! v.01*



87 mm

RENAULT



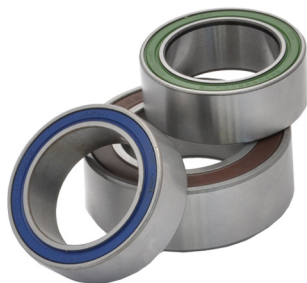

# BEARINGS

ŁOZYSKA-ZASTOSOWANIE

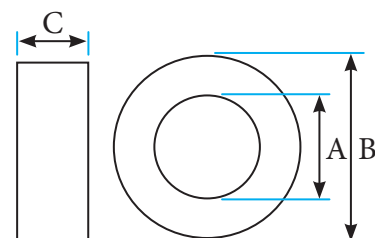

Size AxBxC	Number	Description
Wymiar	Numer	Zastosowanie
10x28x8	AC-03XX30	SANDEN (TRS)
12x28x8	AC-03XX29	FORD (SCROLL)
30x47x12	AC-03XX14	DENSO (SC06)
30x47x18	AC-03XX22	SANDEN (TR70)
30x47x20	AC-03XX15	DENSO (SC06)
30x52x20	AC-03XX16	DENSO (10S11 Series, SCS06C, SCSA06)
30x52x22	AC-03XX01	DENSO (10PA15 Series, 10PA15C - BMW, 10PA15VC, 10PA17 Series, 10PA20 Series, 10S13 Series, 10S15 Series, 10S17 Series, 10S20 Series, TV10 Series, TV12C - R12, TV12C - R134a, TV12EC - R12, TV12SC - R134a, TV14C - R12, TV14EC - R12, TV14SC - R134a)
30x55x23	AC-03XX02	BEHR/BOSCH (Behr Wingcell, Bosch Axial, Bosch Wingcell), DIESEL KIKI (DKS16H - R12, DKS16H - R134a, DKV14B), FORD (FS10, FX15), NIHON (NVR140S), VISTEON (HS15 HS17, HS18, HS20 Series)
30x62x16x24	AC-03XX24	TECUMSEH (HG500, HG850, HG1000), YORK (206, 209, 210, SC206, SC209, YA Series)
30x62x27	AC-03XX25	CHRYSLER (RV2)
32x47x18	AC-03XX13	MATSUSHITA/PANASONIC (H12A1AH4DX), SEIKO-SEIKI (SS10 Series)
32x55x23	AC-03XX03	MATSUSHITA/PANASONIC (N1301 Series, NL1300 Series, S1150 Series, SA1150AE4), SEIKO-SEIKI (SS96 Series)
35x48x20	AC-03XX20	SANDEN (TRSE07)
35x50x20	AC-03XX04	DELPHI (CVC125, CVC135, CVC135E), HALLA (FS18), MITSUBISHI (MSC130 Series), SANDEN (Scroll, SD7B10, TR090, TRF090, TRS090, TR105, TRF105, TRS105 TRSA12), VISTEON (HS090, HS110 Series)
35x52x12	AC-03XX12	DENSO (5SE09C, 5SE12C, 5SL12CJ, 6SEU16, 7SE16C, 7SEU16C)
35x52x20	AC-03XX05	DENSO (7SE16C, SC08, SC08C), DIESEL KIKI (DCS17C, DCS17D), SANDEN (PXE13, PXE16, PXV16, SD7C16)
35x52x22	AC-03XX06	DELPHI (CVC165, CVC185), DENSO (10PA15C, 10PA17C, 6CA17C ,6SEU12 ,7SB16C ,7SBU16C, 7SEU16C)
35x55x20	AC-03XX07	CALSONIC (CR14, CWV615, 617, 618), DIESEL KIKI (DCV11A, DCV14A, DCW17B, DCW17D, DKS13G DKS13S DKS15BH, DKS15CH, DKS15G, DKS15S, DKS17CH, DKS17D, DKS17G, DKS17S, DKV11A, DKV11D, DKV11G, DKV14D, DKV14G), HONDA SYSTEM (RC17D, RC17S), MATSUSHITA/PANASONIC (N1301 Series NL1300 Series), SANDEN (SD505,SD5H Series, SD6V12, SD708, SD709 Series SD709CA, SD709CP, SD7H15, SD7V16, TR090, TRF090, TRS090 TRSA09), SEIKO-SEIKI (SS121 Series), TAMA (TM08HD), VISTEON (VS16)
35x55x22	AC-03XX27	VALEO
35x62x24	AC-03XX17	DIESEL KIKI (DCW17B, DCW17D)
35x62x28	AC-03XX08	DIESEL KIKI (DKS15BH,DKS15CH)
38x54x17	AC-03XX09	DENSO (10P08E), GM/HARRISON (SP10)
40x57x20	AC-03XX18	DENSO (10P17 Series, 10P17VC)
40x57x24	AC-03XX26	
40x62x20,6	AC-03XX10	CALSONIC (V5-15C, V5-15F, V5-15G), DAEWOO (V5), GM/HARRISON (A6, DA6, HD6, HT6, HR6, HR6-HE, HU6, R4 - Lt R4, R4 - Std R4, V5, V7) KEIHIN (150L, 150R)
40x62x20,6x24	AC-03XX23	CHRYSLER (6C17, A590, C171), DENSO (6E171 Series, 6P127 Series, 6P134, 6P148 Series), FORD (FS6), MITSUBISHI (FX105V Series, FX80), TECUMSEH (HR980)
40x62x24	AC-03XX21	CALSONIC (CWV615, 617, 618), DENSO (10P13, 10P15 Series, 10P17 Series, 10P17VC), DIESEL KIKI (DKV14C), HITACHI (A5000, MJS170), MITSUBISHI (MSC105 Series, MSC90 Series), SANDEN (SD507, SD508, SD510), SEIKO-SEIKI (SS170 Series)
40x66x24	AC-03XX11	MITSUBISHI (MSC105 Series, MSC90 Series)
40x68x30	AC-03XX19	

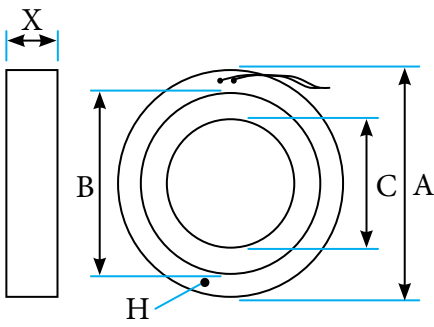

**BOCK**

**4BK01**



A: 206mm B: 145mm  
C: 145mm X: 34mm  
H: - 12V  
 FK4

**CALSONIC**

**4CL01**



A: 96mm B: 64mm  
C: 45mm X: 32mm  
H: 10:30 12V  
 CSE717

**BMW**

**CALSONIC**

**4CL02**



A: 101mm B: 66mm  
C: 45mm X: 27,6mm  
H: 01:15 12V  
 DMV615M

**NISSAN**

**CALSONIC**

**4CL03**



A: 100,9mm B: 66mm  
C: 45mm X: 26mm  
H: 03:45 12V  
 DMV615M

**NISSAN**

**CALSONIC**

**4CL04**



A: 100,9mm B: 66mm  
C: 40mm X: 28mm  
H: 02:00 12V

**NISSAN**

**CALSONIC**

**4CL05**



A: 100,8mm B: 66mm  
C: 45mm X: 26mm  
H: 06:15 12V  
 CR14

**NISSAN**

**CALSONIC**

**4CL06**



A: 96mm B: 64mm  
C: 45mm X: 31,5mm  
H: 06:15 12V

**OPEL**

**CALSONIC**

**4CL07**



A: 103mm B: 72mm  
C: 50mm X: 30mm  
H: 03:00 12V

**NISSAN**

**CALSONIC**

**4CL08**



A: 92mm B: 60mm  
C: 45mm X: 27mm  
H: 10:00 12V  
 CSV617

**NISSAN**

**DELPHI**

**4DL01**



A: 91,8mm B: 60mm  
C: 45mm X: 26,6mm  
H: 10:00 12V  
 CVC

**OPEL**

**DELPHI**

**4DL02**



A: 103mm B: 72mm  
C: 51,6mm X: 35,5mm  
H: - 12V  
 V5

**OPEL**

**DELPHI**

**4DL03**



A: 103mm B: 72mm  
C: 52mm X: 35,5mm  
H: - 12V  
 V5

**RENAULT**

**DELPHI**

**4DL04**



A: 96,2mm B: 62,5mm  
C: 45mm X: 27,2mm  
H: 10:00 12V  
 V5

**RENAULT**

**DELPHI**

**4DL05**



A: 100mm B: 66mm  
C: 45mm X: 25mm  
H: 10:00 12V  
 CVC

**RENAULT/NISSAN**

**DELPHI**

**4DL06**



A: 92mm B: 62mm  
C: 39mm X: 25mm  
H: 06:00 12V  
 CVC

**DAEWOO/HYUNDAI**

**DELPHI**

**4DL07**



A: 103mm B: 72mm  
C: 52mm X: 28mm  
H: - 12V  
 V5

**GM**

**DELPHI**

**4DL08**



A: 92,6mm B: 71,5mm  
C: 51,8mm X: 32,1mm  
H: - 12V  
 V5

**DAEWOO/OPEL**

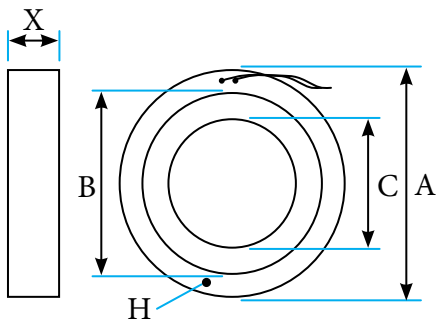

**DELPHI 4DL09**  
 A: 103mm B: 72,1mm  
 C: 51,8mm X: 35,5mm  
 H: - 12V  
 V5  
**VW**

**DELPHI 4DL10**  
 A: 97mm B: 63mm  
 C: 42mm X: 28mm  
 H: 06:00 12V  
**RENAULT**

**DELPHI 4DL11**  
 A: 92mm B: 60mm  
 C: 45mm X: 26mm  
 H: 12V  
 CVC  
**CHEVROLET/OPEL**

**DELPHI 4DL12**  
 A: 83mm B: 55mm  
 C: 40mm X: 29mm  
 H: 03:45 12V  
 QS90  
**CHEVROLET/OPEL**

**DELPHI 4DL13**  
 A: 104mm B: 60mm  
 C: 45mm X: 34mm  
 H: - 12V  
 A6  
**JAGUAR**

**DELPHI 4DL14**  
 A: 103mm B: 72mm  
 C: 52mm X: 36mm  
 H: - 12V  
 V5  
**HYUNDAI**

**DENSO 4DN01**  
 A: 96,6mm B: 61,5mm  
 C: 40mm X: 27,5mm  
 H: 06:00 12V  
 7SB/7SBU  
 10PA15/17/20  
**VW**

**DENSO 4DN02**  
 A: 96,6mm B: 61,5mm  
 C: 40mm X: 27,5mm  
 H: 06:00 12V  
 7SB/7SBU  
**VW**

**DENSO 4DN03**  
 A: 96,6mm B: 61,5mm  
 C: 40mm X: 27,5mm  
 H: 06:00 12V  
 10PA/7SBU  
**BMW/MERCEDES**

**DENSO 4DN04**  
 A: 80mm B: 55mm  
 C: 40mm X: 24,8mm  
 H: 06:00 12V  
 10S08  
**TOYOTA**

**DENSO 4DN05**  
 A: 96mm B: 61mm  
 C: 40mm X: 25mm  
 H: 06:15 12V  
 10S  
**TOYOTA**

**DENSO 4DN06**  
 A: 96mm B: 61mm  
 C: 40mm X: 25mm  
 H: 06:00 12V  
 10S11/13/15/17  
**HONDA/TOYOTA**

**DENSO 4DN07**  
 A: 87mm B: 60mm  
 C: 40mm X: 25mm  
 H: 06:00 12V  
 SCS06/SCSA06  
**FIAT/TOYOTA**

**DENSO 4DN08**  
 A: 96,4mm B: 61,6mm  
 C: 40mm X: 27,6mm  
 H: 06:00 12V  
 10PA  
**KIA/HYUNDAI**

**DENSO 4DN09**  
 A: 97mm B: 66mm  
 C: 50mm X: 33,5mm  
 H: 12:30 12V  
 10P17  
**AUDI/VW**

**DENSO 4DN10**  
 A: 96,3mm B: 61,8mm  
 C: 40mm X: 24,8mm  
 H: 06:30 12V  
**AUDI**

**DENSO 4DN11**  
 A: 96,6mm B: 60,8mm  
 C: 40mm X: 21,7mm  
 H: 06:30 12V  
 6SAS14C  
**AUDI**



**DENSO** **4DN12**  
 A: 96mm B: 61mm  
 C: 40mm X: 25mm  
 H: 06:30  12V  
 6SAS



MERCEDES

**DENSO** **4DN13**  
 A: 96mm B: 61mm  
 C: 40mm X: 22mm  
 H: 06:30  12V  
 6SAS



MERCEDES

**DENSO** **4DN14**  
 A: 96mm B: 61mm  
 C: 40mm X: 22mm  
 H: 06:30  12V  
 6SAS



MERCEDES/NISSAN

**DENSO** **NEW!!! 4DN15**  
 A: 96,5mm B: 61mm  
 C: 40mm X: 25mm  
 H: 06:30  12V  
 6SAS



MERCEDES

**FORD FS** **4FS01**  
 A: 95mm B: 63,5mm  
 C: 63,8mm X: 35,5mm  
 H: -  12V  
 FS/FX



FORD

**FORD FS** **4FS02**  
 A: 101mm B: 66mm  
 C: 63,8mm X: 34mm  
 H: -  12V  
 FS/FX



FORD

**FORD FS** **4FS03**  
 A: 115mm B: 63,5mm  
 C: 63,8mm X: 29,4mm  
 H: -  12V  
 FS/FX



FORD

**HALLA** **4HA01**  
 A: 101mm B: 66mm  
 C: 63,8mm X: 35,5mm  
 H: -  12V  
 HS15/16/17/18



KIA/HYUNDAI

**HALLA** **4HA02**  
 A: 100mm B: 60mm  
 C: 45mm X: 26,5mm  
 H: 03:20  12V  
 HS15



KIA/HYUNDAI

**HALLA** **4HA03**  
 A: 98mm B: 63mm  
 C: 63mm X: 35mm  
 H: -  12V  
 HS18



HYUNDAI

**HALLA** **4HA04**  
 A: 100,8mm B: 66mm  
 C: 63,8mm X: 35,5mm  
 H: -  12V



KIA

**HALLA** **4HA05**  
 A: 96,3mm B: 61,7mm  
 C: 45mm X: 32mm  
 H: 08:15  12V



KIA

**HALLA** **4HA06**  
 A: 100mm B: 60mm  
 C: 45mm X: 26,5mm  
 H: 03:30  12V



KIA

**HALLA** **4HA07**  
 A: 91mm B: 61mm  
 C: 45mm X: 29mm  
 H: -  12V





KIA/HYUNDAI

**HALLA** **4HA08**  
 A: 96mm B: 62mm  
 C: 45mm X: 28mm  
 H: 08:30  12V



KIA/HYUNDAI

**KEIHIN** **4KE01**  
 A: 86mm B: 59mm  
 C: 45mm X: 32mm  
 H: 05:00  12V  
 HS-110R



HONDA CR-V

**KEIHIN** **4KE02**  
 A: 86mm B: 59mm  
 C: 45mm X: 32mm  
 H: 05:00  12V  
 HS-110R



HONDACRV

**KEIHIN** **4KE03**  
 A: 96mm B: 64,3mm  
 C: 45mm X: 32,5mm  
 H: 05:30  12V  
 HS-110R



HONDA

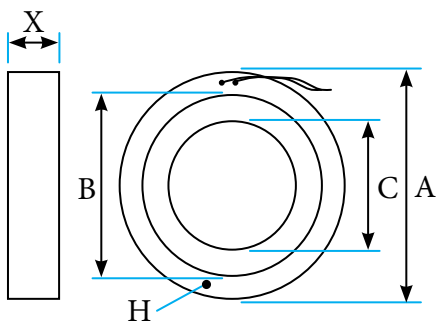

**KEIHIN** **4KE04**

A: 86,2mm B: 57,1mm  
C: 45mm X: 33,3mm  
H: 05:30 12V  
 TRS

**HONDA**

**mitsubishi** **4MI01**

A: 83mm B: 57mm  
C: 40mm X: 31mm  
H: 03:30 12V  
 MSC

**MITSUBISHI**

**MITSUBISHI** **4MI02**

A: 83mm B: 57,6mm  
C: 45mm X: 29,6mm  
H: 04:30 12V  
 MSC

**MITSUBISHI**

**MITSUBISHI** **4MI03**

A: 83mm B: 55,4mm  
C: 40mm X: 27,8mm  
H: 03:00 12V  
 MSC

**MITSUBISHI**

**MITSUBISHI** **4MI04**

A: 87,1mm B: 62,1mm  
C: 39mm X: 26mm  
H: - 12V

**MITSUBISHI**

**MITSUBISHI** **4MI05**

A: 78mm B: 58mm  
C: 40mm X: 27mm  
H: 01:00 12V  
 MSC60

**SUZUKI**

**PANASONIC** **4PA01**

A: 101mm B: 66mm  
C: 42mm X: 32mm  
H: - 12V

**MAZDA**

**PANASONIC** **4PA02**

A: 111,5mm B: 66mm  
C: 42mm X: 32mm  
H: - 12V

**MAZDA3/6**

**PANASONIC** **4PA03**

A: 122mm B: 66mm  
C: 42mm X: 32mm  
H: - 12V

**MAZDA**

**PANASONIC** **4PA04**

A: 88mm B: 59mm  
C: 42mm X: 33mm  
H: 12:00 12V

**MAZDA**

**PANASONIC** **4PA05**

A: 101mm B: 57,4mm  
C: 40mm X: 32,3mm  
H: 02:30 12V

**MAZDA**

**PANASONIC** **4PA06**

A: 95,8mm B: 58,2mm  
C: 40mm X: 25mm  
H: 03:30 12V

**MAZDA**

**PANASONIC** **4PA07**

A: 96mm B: 64mm  
C: 42mm X: 33mm  
H: - 12V

**MAZDA**

**PANASONIC** **4PA08**

A: 101mm B: 66mm  
C: 42mm X: 32,5mm  
H: 12:00 12V

**MAZDA6**

**PANASONIC** **4PA09**

A: 96mm B: 58mm  
C: 40mm X: 25mm  
H: - 12V

**SUZUKI**

**SCROLL** **4SC01**

A: 84mm B: 58mm  
C: 45mm X: 34,2mm  
H: 06:00,09:00 12V  
 SCROLL

**FORD**

**SANDEN** **4SD01**

A: 103mm B: 64mm  
C: 45mm X: 32mm  
H: 05:30 12V  
 SD7V16

**AUDI/SEAT/SKODA/VW**

<p><b>SANDEN</b> <b>4SD02</b></p> <p>A: 86mm B: 59mm C: 45mm X: 31mm H: 05:30  12V  SD6V12</p> <p>OPEL</p>	<p><b>SANDEN</b> <b>4SD03</b></p> <p>A: 103mm B: 64mm C: 45mm X: 27,2mm H: 05:30  12V  SD7V16</p> <p>VW</p>	<p><b>SANDEN</b> <b>4SD04</b></p> <p>A: 96mm B: 61mm C: 45mm X: 27,6mm H: 09:00  12V  SD7V16</p> <p>OPEL</p>
<p><b>SANDEN</b> <b>4SD05</b></p> <p>A: 96mm B: 61mm C: 45mm X: 27,6mm H: 05:30  12V  PXV</p> <p>OPEL</p>	<p><b>SANDEN</b> <b>4SD06</b></p> <p>A: 96mm B: 61mm C: 45mm X: 26mm H: 09:00  12V  SD6V12</p> <p>CITROEN/PEUGEOT</p>	<p><b>SANDEN</b> <b>4SD07</b></p> <p>A: 96mm B: 64mm C: 45mm X: 32mm H: 09:15  12V  SD7V16</p> <p>CITROEN/PEUGEOT</p>
<p><b>SANDEN</b> <b>4SD08</b></p> <p>A: 96mm B: 64mm C: 45mm X: 32mm H: 05:25  12V  SD7H15</p>	<p><b>SANDEN</b> <b>4SD09</b></p> <p>A: 96mm B: 64mm C: 45mm X: 32,5mm H: 05:30  12V  SD7V16/SD6V12</p> <p>CITROEN/PEUGEOT/FIAT/RENAULT</p>	<p><b>SANDEN</b> <b>4SD10</b></p> <p>A: 103mm B: 64mm C: 45mm X: 32mm H: 05:20  12V  SD7V16</p> <p>AUDI/SEAT/SKODA/VW</p>
<p><b>SANDEN</b> <b>4SD11</b></p> <p>A: 96mm B: 64mm C: 45mm X: 30mm H: 05:30  12V</p>	<p><b>SANDEN</b> <b>4SD12</b></p> <p>A: 86,2mm B: 57,1mm C: 45mm X: 35,5mm H: 05:30  12V  TRS</p> <p>HONDA</p>	<p><b>SANDEN</b> <b>4SD13</b></p> <p>A: 96mm B: 64mm C: 45mm X: 32mm H: 05:25  12V</p> <p>CITROEN/PEUGEOT</p>
<p><b>SANDEN</b> <b>4SD14</b></p> <p>A: 103mm B: 72mm C: 50,5mm X: 38,5mm H: 05:30  12V  SD7V16</p>	<p><b>SANDEN</b> <b>4SD15</b></p> <p>A: 103mm B: 61mm C: 45mm X: 33mm H: 06:00  12V  SD6C12</p> <p>CITROEN/PEUGEOT</p>	<p><b>SANDEN</b> <b>4SD16</b></p> <p>A: 96mm B: 61mm C: 45mm X: 33mm H: 06:00  12V  SD6C12</p> <p>CITROEN/PEUGEOT</p>
<p><b>SANDEN</b> <b>4SD17</b></p> <p>A: 81mm B: 58mm C: 45mm X: 34mm H: 07:00  12V  TRS09</p> <p>HONDA</p>	<p><b>SANDEN</b> <b>4SD18</b></p> <p>A: 86mm B: 59mm C: 45mm X: 31mm H: 05:00  12V  TRS09</p> <p>HONDA</p>	<p><b>SANDEN</b> <b>4SD19</b></p> <p>A: 86mm B: 59mm C: 45mm X: 33mm H: 05:30  12V  TRS09</p> <p>OPEL</p>



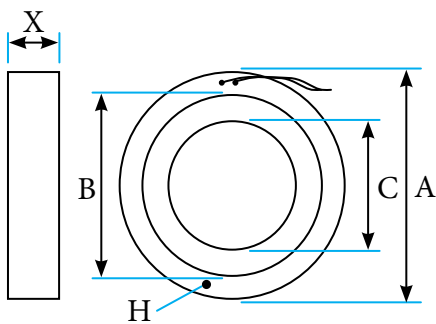

SANDEN

4SD30



A: 86mm B: 59mm  
C: 45mm X: 34mm  
H: 06:30 12V  
 SD6V12

SEAT/SKODA/VW

SANDEN

4SD31



A: 113mm B: 72mm  
C: 45mm X: 33mm  
H: 05:30 12V  
 SD7H15

SPECIAL VEHICLES

SANDEN

4SD32



A: 103mm B: 61mm  
C: 45mm X: 28mm  
H: 05:30 12V  
 PX

OPEL

SANDEN

4SD33



A: 96mm B: 61mm  
C: 45mm X: 28mm  
H: 05:30 12V  
 PX

VOLVO/FORD/JAGUAR/LAN DROVER

SANDEN

4SD34



A: 103mm B: 61mm  
C: 45mm X: 33mm  
H: 06:00 12V  
 SD7V16

VW

SANDEN

4SD35



A: 86mm B: 59mm  
C: 45mm X: 33mm  
H: 05:30 12V  
 SD7V16

HONDA

SANDEN

**NEW!!!**  
4SD36



A: 96mm B: 61mm  
C: 45mm X: 28mm  
H: 05:30 12V  
 PXC14

MERCEDES

SEIKO-SEIKI

4SS01



A: 86mm B: 55mm  
C: 40mm X: 23mm  
H: 09:00 12V

BMW/SUZUKI

SEIKO-SEIKI

4SS02



A: 96mm B: 64mm  
C: 40mm X: 27mm  
H: 08:00 12V

BMW

SEIKO-SEIKI

4SS03



A: 96mm B: 64mm  
C: 40mm X: 27mm  
H: 08:30 12V  
 SS1201

BMW

SEIKO-SEIKI

4SS04



A: 92mm B: 55mm  
C: 40mm X: 24mm  
H: 07:30 12V

CITROEN/PEUGEOT

VISTEON

4VI01



A: 97mm B: 63,5mm  
C: 45mm X: 31mm  
H: 12:00 12V  
 VS16

FORD

VISTEON

4VI02



A: 101mm B: 66mm  
C: 45mm X: 29,5mm  
H: 12:00 12V  
 VS16

FORD

VISTEON

4VI03



A: 101mm B: 66mm  
C: 45mm X: 29,5mm  
H: 12:00 12V  
 VS16

FORD

VISTEON

4VI04



A: 97mm B: 64mm  
C: 45mm X: 31,5mm  
H: 12:00 12V  
 VS16

FORD

YORK

4YO01



A: 116mm B: 67mm  
C: 67mm X: 40mm  
H: - 12V



YORK

4YO02



A: 116mm B: 74mm  
C: 74mm X: 38mm  
H: - 12V

**ZEXEL** **4ZX01**

A: 101mm B: 66mm  
C: 40mm X: 28mm  
H: 01:30  12V  
 TM 08/11/13/  
15/16



**ZEXEL** **4ZX02**

A: 101mm B: 66mm  
C: 45mm X: 27,2mm  
H: 01:00  12V  
 DSC17/KC88



**OPEL/RENAULT/NISSAN**

**ZEXEL** **4ZX03**

A: 96mm B: 64mm  
C: 45mm X: 33mm  
H: 01:00  12V  
 KC-88



**VOLVO**

**ZEXEL** **4ZX04**

A: 105mm B: 66mm  
C: 40mm X: 28mm  
H: 02:50  12V  
 DKS17



**VOLVO**

**ZEXEL** **4ZX05**

A: 100mm B: 66mm  
C: 45mm X: 27mm  
H: 01:00  12V  
 DCS17



**NISSAN**

**ZEXEL** **4ZX06**

A: 101mm B: 66mm  
C: 40mm X: 28,5mm  
H: 02:30  12V



**NISSAN**

**ZEXEL** **4ZX07**

A: 86mm B: 55mm  
C: 40mm X: 23mm  
H: 09:00  12V  
 DKV08R



**NISSAN**

**ZEXEL** **4ZX08**

A: 105mm B: 65mm  
C: 40mm X: 37mm  
H: 02:00  12V  
 DKS-15D



**FORD/VOLVO**

**ZEXEL** **4ZX09**

A: 85mm B: 55mm  
C: 40mm X: 26mm  
H: 09:00  12V  
 DKV-08R



**SUZUKI**



**ZEXEL** **4ZX10**

A: 85mm B: 55mm  
C: 40mm X: 25mm  
H: -  12V



**SUZUKI**

**ZEXEL** **4ZX11**

A: 105mm B: 65mm  
C: 45mm X: 30mm  
H: 01:00  12V  
 DCW-17D



**AUDI/FORD/SEAT/SKODA/WV**

**ZEXEL** **4ZX12**

A: 96mm B: 64mm  
C: 45mm X: 33,5mm  
H: 01:00  12V



**SUZUKI**

**ZEXEL** **4DL20**

A: 103mm B: 72mm  
C: 52mm X: 36mm  
H: -  24V



**SPECIAL VEHICLES**

**DELPHI** **4DL21**

A: 104mm B: 60mm  
C: 45mm X: 34mm  
H: -  24V  
 A6



**DENSO** **4DN20**

A: 96,2mm B: 61,5mm  
C: 40mm X: 27,5mm  
H: 06:00  24V  
 7SB/7SBU  
10PA15/17/20



**SANDEN** **4SD20**

A: 103mm B: 72mm  
C: 50mm X: 38,5mm  
H: 05:30  24V  
 SD7H15



**SANDEN** **4SD21**

A: 96mm B: 64mm  
C: 45mm X: 31,6mm  
H: 05:30  24V  
 SD7H15



**SANDEN** **4SD22**

A: 96mm B: 64mm  
C: 45mm X: 32mm  
H: 05:30  24V  
 SD7H15



**VOLVO**

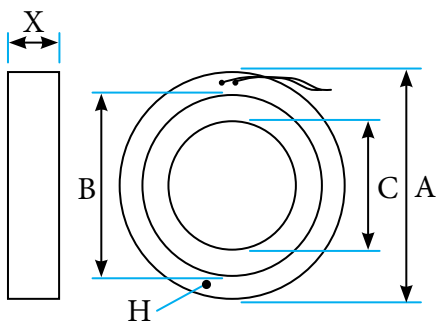

SANDEN

4SD23



A: 113mm B: 72mm  
C: 45mm X: 33mm  
H: 05:30 24V  
 SD7H15

SANDEN

4SD24



A: 103mm B: 64mm  
C: 45mm X: 32mm  
H: 05:30 24V  
 SD7H15

SPECIAL VEHICLES

YORK

4YO20



A: 116,5mm B: 67mm  
C: 67mm X: 40mm  
H: 02:00 24V

ZEXEL

4ZX20



A: 103mm B: 72mm  
C: 50mm X: 39mm  
H: 05:30 24V  
 SD5H14

ZEXEL

4ZX21



A: 101mm B: 66mm  
C: 40mm X: 28mm  
H: 01:30 24V  
 TM/08/11/13/  
15/16

ZEXEL

4ZX22



A: 105mm B: 66mm  
C: 40mm X: 28mm  
H: 02:45 24V  
 DKS17

ZEXEL

4ZX23



A: 101mm B: 66mm  
C: 40mm X: 27,7mm  
H: 01:30 24V  
 TM/08/11/13/  
15/16

ZEXEL

4ZX24



A: 121mm B: 79mm  
C: 50mm X: 43mm  
H: 02:00 24V  
 DKS320/TM31



# COILS

Elektromagnesny - tabela

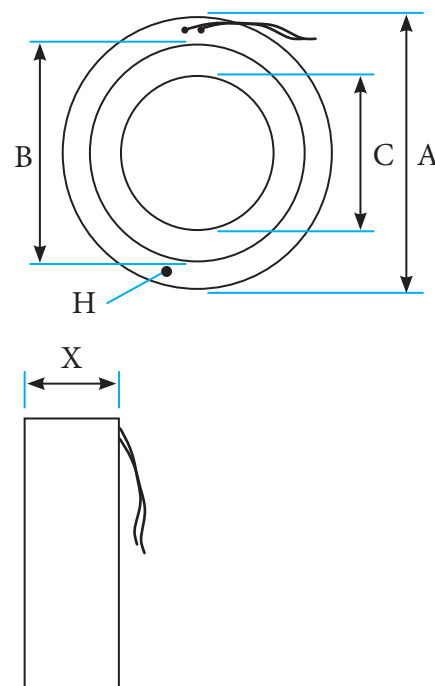

	<b>A</b> Out. Diam. Wymiar zewnątrzny	<b>B</b> In. Diam wymiar wewnętrzny	<b>C</b> Mounting hole diam. Średnica osadzenia	<b>X</b> Height wysokość cewki	<b>H</b> Clock sposób montażu
<b>12 V</b>					
4BK01	206	145	145	34	-
4CL01	96	64	45	32	10:30
4CL02	101	66	45	27,6	1:15
4CL03	100,9	66	45	26	3:45
4CL04	100,9	66	40	28	2:00
4CL05	100,8	66	45	26	6:15
4CL06	96	64	45	31,5	6:15
4CL07	103	72	50	30	2:50
4CL08	92	60	45	27	10:30
4DL01	91,8	60	45	26,6	10:00
4DL02	103	72	51,6	35,5	-
4DL03	103	72	52	35,5	-
4DL04	96,2	62,5	45	27,2	10:00
4DL05	100	66	45	25	10:00
4DL06	92	62	39	25	6:00
4DL07	103	72	52	28	-
4DL08	92,6	71,5	51,8	32,1	-
4DL09	102,9	72,1	51,8	35,5	-
4DL10	97	63	42	28	6:00
4DL11	92	60	45	26	-
4DL12	83	55	40	29	3:45
4DL13	104	60	45	34	-
4DL14	103	72	52	36	-
4DN01	96,6	61,5	40	27,5	6:00
4DN02	96,6	61,5	40	27,5	6:00
4DN03	96,6	61,5	40	27,5	6:00
4DN04	80	55	40	24,8	6:00
4DN05	96	61	40	25	6:15
4DN06	96	61	40	25	6:00
4DN07	87	60	40	25	6:00
4DN08	96,4	61,6	40	27,6	6:00
4DN09	97	66	50	33,5	12:30
4DN10	96,5	61,8	40	24,8	6:15
4DN11	96,6	60,8	40	21,7	6:15
4DN12	96	61	40	25	6:30
4DN13	96	61	40	22	6:30
4DN14	96	61	40	22	6:30
4DN15	96,5	61	40	25	6:30
4FS01	95	63,5	63,8	35,5	-
4FS02	101	66	63,8	34	-
4FS03	115	63,5	63,8	29,4	-
4HA01	101	66	63,8	35,5	-
4HA02	100	60	45	26,5	3:20
4HA03	98	63	63	35	-
4HA04	100,8	66	63,8	35,5	-
4HA05	96,3	61,7	45	32	8:15
4HA06	100	60	45	26,5	3:30
4HA07	91	61	45	29	3:00
4HA08	96	62	45	28	8:30
4KE01	86	59	45	32	5:00
4KE02	86	59	45	32	5:00
4KE03	96	64,3	45	32,5	5:30
4KE04	86,2	57,1	45	33,3	5:30
4MI01	83	57	40	31	3:30
4MI02	83	57,6	45	29,6	4:30
4MI03	83	55,4	40	27,8	3:00
4MI04	87,2	62,2	39	26	-
4MI05	78	58	40	27	1:30
4PA01	101	66	42	32	-
4PA02	111,5	66	42	32	-
4PA03	122	66	42	32	-
4PA04	88	59	42	33	12:00

# COILS

Elektromagnesy - tabela

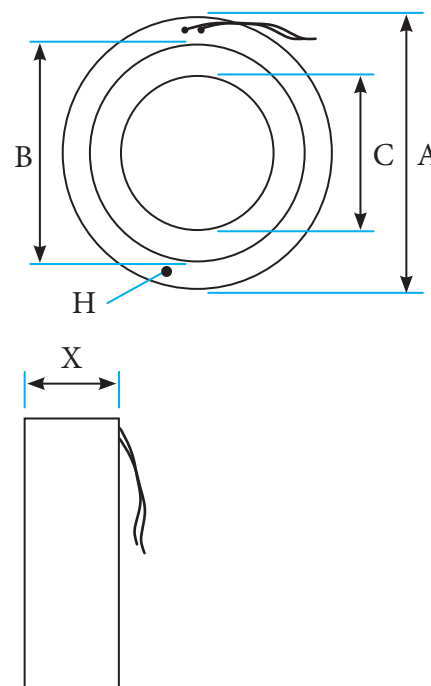

	<b>A</b> Out. Diam. Wymiar zewnątrzny	<b>B</b> In. Diam wymiar wewnętrzny	<b>C</b> Mounting hole diam. średnica osadzenia	<b>X</b> Height wysokość cewki	<b>H</b> Clock sposób montażu
<b>12 V</b>					
4PA05	101	57,4	40	32,3	2:30
4PA06	95,8	58,2	40	25	3:30
4PA07	96	64	42	33	-
4PA08	101	66	42	32,5	12:00
4PA09	96	58	40	25	3:30
4SC01	84	58	45	34,2	00:09.1
4SD01	103	64	45	32	5:30
4SD02	86	59	45	31	5:30
4SD03	103	64	45	27,2	5:30
4SD04	96	61	45	27,6	9:00
4SD05	96	61	45	27,6	5:30
4SD06	96	61	45	26	9:00
4SD07	96	64	45	32	9:15
4SD08	96	64	45	32	5:25
4SD09	96	64	45	32,5	5:30
4SD10	103	64	45	32	5:20
4SD11	96	64	45	30	5:30
4SD12	86,2	57,1	45	35,5	5:30
4SD13	96	64	45	32	5:25
4SD14	103	72	50,5	38,5	5:30
4SD15	103	61	45	33	6:00
4SD16	96	61	45	33	6:00
4SD17	81	58	45	34	5:30
4SD18	86	59	45	31	5:00
4SD19	86	59	45	33	5:30
4SD30	86	59	45	34	6:30
4SD31	113	72	45	33	5:30
4SD32	103	61	45	28	5:30
4SD33	96	61	45	28	5:30
4SD34	103	61	45	33	6:00
4SD35	86	59	45	33	5:30
6SD36	96	61	45	29	5:30
4SS01	86	55	40	23	9:00
4SS02	96	64	40	27	8:00
4SS03	96	64	40	27	8:30
4SS04	92	55	40	24	7:30
4VI01	97	63,5	45	31	12:00
4VI02	101	66	45	29,5	12:00
4VI03	101	66	45	29,5	12:00
4VI04	97	64	45	34	12:00
4YO01	116,5	67	67	40	-
4YO02	116,5	74,5	74,5	38,5	-
4ZX01	101	66	40	28	1:30
4ZX02	101	66	45	27,2	1:00
4ZX03	96	64	45	33	1:00
4ZX04	105	66	40	28	2:50
4ZX05	100	66	45	27	1:00
4ZX06	101	66	40	28,5	2:30
4ZX07	86	55	40	23	9:00
4ZX08	105	65	40	37	3:00
4ZX09	85	55	40	26	9:00
4ZX10	85	55	40	25	9:00
4ZX11	105	65	45	30	1:00
4ZX12	96	64	45	33,5	1:00
<b>24 V</b>					
4DL20	103	72	52	36	-
4DL21	104	60	45	34	-
4DN20	96,2	61,5	40	27,5	6:00
4SD20	103	72	50	38,5	5:30
4SD21	96	64	45	31,6	5:30
4SD22	96	64	45	32	5:30
4SD23	113	72	45	33	5:30
4SD24	103	64	45	32	5:30
4YO20	116,5	67	67	40	2:00
4ZX20	103	72	50	39	5:30
4ZX21	101	66	40	28	1:30
4ZX22	105	66	40	28	2:45
4ZX23	101	66	40	27,7	1:30
4ZX24	121	79	50	43	5:30

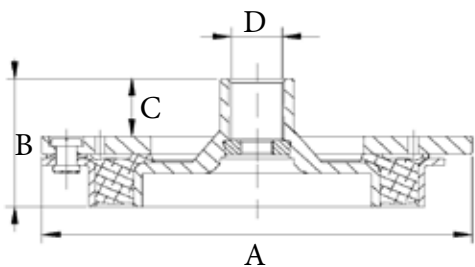

**CALSONIC** **5CL01**

A: 109,5 mm  
B: 32,7 mm  
C: 15,7 mm

**BMW**

**CALSONIC** **5CL02**

A: 115 mm  
B: 21,2 mm  
C: 11,2 mm

**NISSAN**

CWV618

**CALSONIC** **5CL03**

A: 110 mm  
B: 19 mm  
C: 10 mm

**NISSAN**

CWV615M

**CALSONIC** **5CL04**

A: 110 mm  
B: 16,5 mm  
C: 6 mm

**NISSAN**

CWV615M

**CALSONIC** **5CL05**

A: 90 mm  
B: 21 mm  
C: 13 mm

**BMW**

CSE717

**DELPHI** **5DL01**

A: 90 mm  
B: 19,5 mm  
C: 9,5 mm

**OPEL**

CVC

**DELPHI** **5DL02**

A: 105 mm  
B: 26 mm  
C: 13,3 mm

**OPEL**

CVC

**DELPHI** **5DL03**

A: 90 mm  
B: 19,5 mm  
C: 10 mm

**VW**

CVC

**DELPHI** **5DL04**

A: 110 mm  
B: 23 mm  
C: 10,2 mm

**RENAULT/NISSAN**

CVC

**DELPHI** **5DL05**

A: 86 mm  
B: 25 mm  
C: 15 mm

**OPEL**

ZJ/ZL/ZM/  
ZK2

**DELPHI** **5DL06**

A: 128 mm  
B: 32 mm  
C: 23,2 mm

**V5**

**DELPHI** **5DL07**

A: 120 mm  
B: 34 mm  
C: 23,2 mm

**V5**

**DELPHI** **5DL08**

A: 111 mm  
B: 34 mm  
C: 23,2 mm

**V5**

**DELPHI** **5DL09**

A: 108 mm  
B: 21 mm  
C: 10 mm

**SP17**

**CHEVROLET**

**DELPHI** **5DL10**

A: 105 mm  
B: 28 mm  
C: 12,2 mm

**CVC**

**OPEL/CHEVROLET**

**DELPHI** **5DL11**

A: 75 mm  
B: 19 mm  
C: -

**DH5**

**AUDI/ SEAT/SKODA/ VW**

**DELPHI** **5DL12**

A: 92 mm  
B: 11 mm  
C: -

**QS90**

**OPEL**



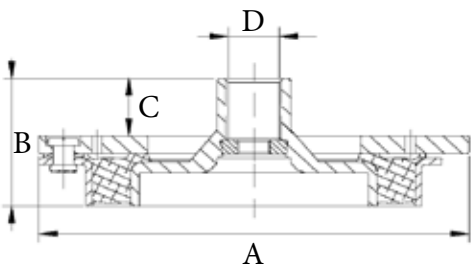

**DELPHI** **5DL13**

A: 118 mm  
B: 51 mm  
C: 28,5 mm

A6

AUDI/ FORD/ MB/JAGUAR/SPEC. VEH.

**DELPHI** **5DL14** NEW!!! v.01

A: 115 mm  
B: 24 mm  
C: 13,4 mm

QS90

OPEL

**DENSO** **5DN01**

FOR 5DN04  
(HIGHER 17,3mm)

6SEU/7SEU

**DENSO** **5DN02**

A: -  
B: -  
C: -

5SL, 5SE,  
6SEU, 7SEU

**DENSO** **5DN03**

A: 83 mm  
B: 19,6 mm  
C: -

5SL, 5SE,  
6SEU, 7SEU

**DENSO** **5DN04**

A: 74,5 mm  
B: 22,3 mm

FOR 5DN01  
(HIGHER 18mm)

6SEU, 7SEU

**DENSO** **5DN05**

A: -  
B: -  
C: -

FOR 5DN06  
(LOWER 14,5mm)

6SEU/7SEU

**DENSO** **5DN06**

A: 74,5 mm  
B: 22,3 mm

FOR 5DN05  
(LOWER 15mm)

6SEU/7SEU

**DENSO** **5DN07**

A: 83 mm  
B: 19,2 mm  
C: -

6SEU, 5SL,  
5SE

BMW/TOYOTA

**DENSO** **5DN08**

A: -  
B: -  
C: -

6SEU, 5SL,  
5SE

BMW/TOYOTA

**DENSO** **5DN09**

A: 84 mm  
B: 30 mm  
C: -

6SEU, 5SL,  
5SE

AUDI

**DENSO** **5DN10**

A: 85,5 mm  
B: 29 mm  
C: -

6SEU/7SEU

MERCEDES

**DENSO** **5DN11**

A: 83 mm  
B: 31,6 mm  
C: -

5SL, 5SE

**DENSO** **5DN12**

A: -  
B: -  
C: -  
21MM

**DENSO** **5DN13**

A: 105 mm  
B: 39 mm  
C: 19,4 mm

7SB/7SBU/6CA17  
10PA/11/13/  
15/17/20

**DENSO** **5DN14**

A: 135 mm  
B: 34,5 mm  
C: 18 mm

6SEU12C

TOYOTA

**DENSO** **5DN15**

A: -  
B: -  
C: -  
23 MM

**DENSO** **5DN16**



A: -  
B: -  
C: -  
48 MM

FIAT/TOYOTA

**DENSO** **5DN17**



A: 93,5 mm  
B: 24,9 mm  
C: 16,8 mm

SCSA06,  
SCSB06

FIAT/TOYOTA

**DENSO** **5DN18**



A: 93,5 mm  
B: 23,2 mm  
C: 15,7 mm

SCSA06 /  
SCSB06

FIAT/TOYOTA

**DENSO** **5DN19**



A: 94 mm  
B: 38 mm  
C: -

6SE

LEXUS/TOYOTA

**DENSO** **5DN20**



A: 102 mm  
B: 32 mm  
C: 16,5 mm

10S

SUZUKI

**DENSO** **5DN21**



A: 88 mm  
B: 20,3 mm  
C: 12,2 mm

SCSA06,  
SCSB06

FIAT/TOYOTA

**DENSO** **5DN22**



A: 94 mm  
B: 21,7 mm  
C: 13,9 mm

SCSA06,  
SCSB06

FIAT/TOYOTA

**DENSO** **5DN23**



A: -  
B: -  
C: -

10SEU17C

AUDI/VW/LAMBORGHINI

**DENSO** **5DN24**



A: -  
B: -  
C: -

10SEU17C

AUDI/VW/LAMBORGHINI

**DENSO** **5DN25**



A: 102 mm  
B: 30 mm  
C: 12 mm

6SEU16C/  
6SBU16C

MERCEDES

**DENSO** **5DN27**



A: 84 mm  
B: 27,5 mm  
C: 18 mm

6SEU16C/  
6SBU16C

AUDI/VW

**DENSO** **5DN28**



A: 96 mm  
B: 37 mm  
C: -

5TSE10C

TOYOTA

**DENSO** **5DN29**



A: 98 mm  
B: 23,7 mm  
C: 12,5 mm

6SAS14C

AUDI

**DENSO** **5DN30**



A: 110 mm  
B: 37 mm  
C: -

5TSE10C

TOYOTA

**DENSO** **5DN31** NEW!!!  
v. 01



A: 98 mm  
B: 24 mm  
C: 12,5 mm

6SB/7SB

TOYOTA

**DENSO** **5DN32**



A: 104 mm  
B: 35,5 mm  
C: -

5SE09

TOYOTA

**DENSO** **5DN33**



A: -  
B: -  
C: -

6SEU, 5SL,  
5SE

BMW/TOYOTA

**DENSO** **5DN35**



A: 89 mm  
B: 33,5 mm  
C: -

5SL12C

FIAT/ OPEL

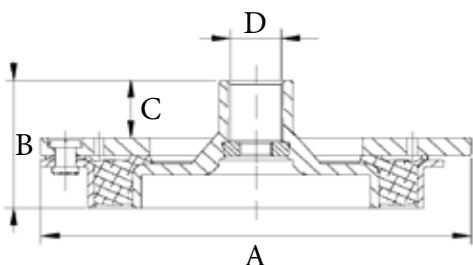

**FORD FS** **5FS01**

A: 122 mm  
B: 31 mm  
C: 15,7 mm

FS

**FORD**

**FORD FS** **5FS02**

A: 122 mm  
B: 31 mm  
C: 21,3 mm

FS10

**FORD**

**FORD FS** **5FS03**

A: 122 mm  
B: 28 mm  
C: 17 mm

FS

**FORD**

**HALLA** **5HA01**

A: 105 mm  
B: 34,8 mm  
C: 15,4 mm

HS18

**HYUNDAI/KIA**

**HALLA** **5HA02**

A: 109,5 mm  
B: 37 mm  
C: 20 mm

**HYUNDAI/KIA**

**HALLA** **5HA03**

A: 105 mm  
B: 37 mm  
C: 20 mm

VS16

**HYUNDAI**

**HALLA** **5HA04**

A: 110 mm  
B: 38 mm  
C: 21 mm

VS16

**HYUNDAI**

**HALLA** **5HA05**

A: -  
B: -  
C: -

**HYUNDAI/KIA**

**HALLA** **5HA06**

A: -  
B: -  
C: -

**HYUNDAI/KIA**

**HALLA** **5HA07**

A: 98,5 mm  
B: 24,5 mm  
C: 14 mm

**HYUNDAI**

**HALLA** **5HA08**

A: 100 mm  
B: 34 mm  
C: 16,6 mm

**HYUNDAI/ KIA**

**HALLA** **5HA09**

A: 109 mm  
B: 38,9 mm  
C: 18,8 mm

HS-15

**FORD**

**KEIHIN** **5KE01**

A: 102 mm  
B: 20 mm  
C: 6,1 mm

HS-110R

**HONDA**

**MITSUBISHI** **5MI01**

A: 94 mm  
B: 14 mm  
C: 1,6 mm

MSC060

**MITSUBISHI**

**MITSUBISHI** **5MI02**

A: -  
B: -  
C: -

MSC

**MITSUBISHI**

**MITSUBISHI** **5MI03**

A: 92 mm  
B: 11,5 mm  
C: 2,8 mm

QS90

**MITSUBISHI**

**MITSUBISHI** **5MI04**

A: 92 mm  
B: 14 mm  
C: 3 mm

**MITSUBISHI**



**PANASONIC** **5PA01**  
  
 A: 109,5 mm  
 B: 47 mm  
 C: 30,2 mm  
**MAZDA**

**PANASONIC** **5PA02**  
  
 A: 102 mm  
 B: 47 mm  
 C: 30,2 mm  
**MAZDA**

**PANASONIC** **5PA03**  
  
 A: 95 mm  
 B: 50 mm  
 C: 34 mm  
**MAZDA**

**PANASONIC** **5PA04**  
  
 A: 109,5 mm  
 B: 35,5 mm  
 C: 18,5 mm  
**MAZDA**

**PANASONIC** **5PA05**  
  
 A: 104,3 mm  
 B: 27 mm  
 C: 10,3 mm  
**MAZDA**



**PANASONIC** **5PA06**  
  
 A: 110 mm  
 B: 27 mm  
 C: 10 mm  
**MAZDA**

**PANASONIC** **5PA07**  
  
 A: 95 mm  
 B: 23,5 mm  
 C: 10,8 mm  
**SUZUKI**

**SCROLL** **5SC01**  
  
 A: 107,4 mm  
 B: 18 mm  
 C: 5 mm  
 **SCROLL**  
**FORD**

**SANDEN** **5SD01**  
  
 A: 106 mm  
 B: 28 mm  
 C: 5,5 mm  
 **PXE13/  
 PXE16**  
**AUDI/SEAT/SKODA/VW**

**SANDEN** **5SD02**  
  
 A: 91 mm  
 B: 26 mm  
 C: 16 mm  
 **PXE14/  
 PXE16**  
**AUDI/SEAT/SKODA/VW**

**SANDEN** **5SD03**  
  
 A: 105 mm  
 B: 27,7 mm  
 C: 10 mm  
 **PXV16**  
**OPEL**

**SANDEN** **5SD04**  
  
 A: 105 mm  
 B: 28 mm  
 C: 14 mm  
 **SD6V12/  
 SD7V16/  
 SD7H15**

**SANDEN** **5SD05**  
  
 A: 105 mm  
 B: 27 mm  
 C: 14 mm  
 **SD7V16**  
**AUDI/SEAT/SKODA/VW**

**SANDEN** **5SD06**  
  
 A: 105 mm  
 B: 30,2 mm  
 C: 13 mm  
 **SD7V16**

**SANDEN** **5SD07**  
  
 A: 90 mm  
 B: 21 mm  
 C: 11,5 mm  
 **PXE16**

**SANDEN** **5SD08**  
  
 A: 90,5 mm  
 B: 26 mm  
 C: 16,2 mm  
 **PXE**  
**OPEL**

**SANDEN** **5SD09**  
  
 A: 110,5 mm  
 B: 32,2 mm  
 C: 15 mm

**SANDEN** **5SD10**  
  
 A: 105 mm  
 B: 32 mm  
 C: 14,8 mm  
 **PX**  
**OPEL/SAAB**

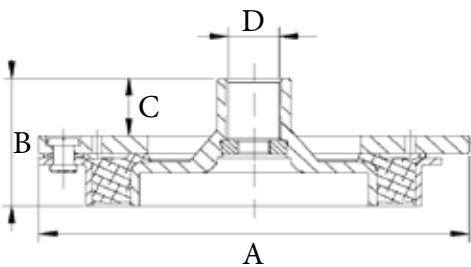

**SANDEN** **5SD11**

A: 106 mm  
B: 22,1 mm  
C: 12,9 mm

SD7H15/  
SD7V16/  
SD6V12

**SANDEN** **5SD12**

A: 105 mm  
B: 17 mm  
C: 4,4 mm

TRS

**HONDA**

**SANDEN** **5SD13**

A: 105 mm  
B: 18,8 mm  
C: 6 mm

TRS

**HONDA**

**SANDEN** **5SD14**

A: 105 mm  
B: 18 mm  
C: 8,9 mm

SD7C16

**CITROEN/PEUGEOT**

**SANDEN** **5SD15**

A: 105 mm  
B: 22,7 mm  
C: 10,3 mm

PXC16

**FORD/OPEL**

**SANDEN** **5SD17**

A: 105 mm  
B: 28 mm  
C: 13 mm

SD6V12

**SEAT/ VW**

**SANDEN** **5SD18**

A: 105 mm  
B: 20 mm  
C: 10 mm

SD7H15

**CHRYSLER/JEEP**

**SANDEN** **5SD19**

A: 102 mm  
B: 31 mm  
C: 13,5 mm

PXC14

**MERCEDES**

**SEIKO-SEIKI** **5SS01**

A: 103,7 mm  
B: 32,8 mm  
C: 19 mm

S120DL1

**BMW**

**SEIKO-SEIKI** **5SS02**

A: 109 mm  
B: 41 mm  
C: 24 mm

S120DL1

**BMW**

**VISTEON** **5VI01**

A: 116 mm  
B: 38,2 mm  
C: 21 mm

VS

**FORD/VOLVO**

**VISTEON** **5VI02**

A: 115 mm  
B: 36,9 mm  
C: 20 mm

VS16

**FORD**

**VISTEON** **5VI03**

A: 110 mm  
B: 40 mm  
C: 21 mm

VS

**FORD**

**VISTEON** **5VI04**

A: 115 mm  
B: 41 mm  
C: 23 mm

VS-16

**FORD**

**VISTEON** **5VI05**

A: 87 mm  
B: 25,5 mm  
C: 13,9 mm

CMP01

**BMW**

**VISTEON** **5VI06**

A: 115 mm  
B: 40 mm  
C: 21,3 mm

VS

**FORD**

**YORK** **5YO01** *NEW!!! v.01*

A: 134 mm  
B: 45 mm  
C: 34 mm

VS

**ZEXEL** **5ZX01**



A: 92 mm  
B: 22,5 mm  
C: -

 DCS17E

**VW**

**ZEXEL** **5ZX02**



A: 85,5 mm  
B: 22 mm  
C: 4 mm

 DCS17/  
KC88

**MERCEDES**

**ZEXEL** **5ZX03**



A: 112,2 mm  
B: 32,5 mm  
C: 16 mm

 TM 16/15/  
13/11/08

**ZEXEL** **5ZX04**



A: 112 mm  
B: 22 mm  
C: 9 mm

 KC 88/DKS

**VOLVO**

**ZEXEL** **5ZX05**



A: 112,2 mm  
B: 32,5 mm  
C: 16 mm

 DKS17D

**VOLVO**

**ZEXEL** **5ZX06**



A: 111 mm  
B: 36,4 mm  
C: 24 mm

**ZEXEL** **5ZX07**



A: 110 mm  
B: 18 mm  
C: 6,5 mm

 KC 88/  
DCS17

**NISSAN/ OPEL/RENAULT**

**ZEXEL** **5ZX08**



A: 92 mm  
B: 22,5 mm  
C: 11,5 mm

 DKV08R

**NISSAN**

**ZEXEL** **5ZX09**



A: 100 mm  
B: 21 mm  
C: 12,3 mm

 DKV-10R

**SUBARU**

**ZEXEL** **5ZX10**



A: 140 mm  
B: 41,4 mm  
C: 24 mm

 DKS320

**MITSUBISHI/TOYOTA**

**ZEXEL** **5ZX11**



A: 92 mm  
B: 21 mm  
C: 12 mm

 DKV-08R

**SUZUKI**

**ZEXEL** **5ZX12**



A: 95 mm  
B: 25 mm  
C: 12,2 mm

 DKV-10R

**SUBARU**

**ZEXEL** **5ZX13**



A: 105,3 mm  
B: 25 mm  
C: 7,9 mm

 DCS17IC

**ALFA ROMEO/FIAT/ LANCIA**

**ZEXEL** **NEW!!!** **5ZX14**  
v.01



A: 150 mm  
B: 43 mm  
C: 27 mm

 TM43

**ZEXEL** **NEW!!!** **5ZX15**  
v.01



A: 185 mm  
B: 58 mm  
C: 35 mm

 TM65



	A	B	C	D
5CL01	109,5	32,7	15,7	12,5x23x0,5
5CL02	115	21,2	11,2	13,5x25x0,5
5CL03	110	19	10	13,5x25
5CL04	110	16,5	6	13x25
5CL05	90	21	13	11x
5DL01	90	19,5	9,5	12,5x23x0,5
5DL02	105	26	13,3	12,5x23x0,5
5DL03	90	19,5	10	12,5x23x0,5
5DL04	110	23	10,2	-
5DL05	86	25	15	12,5x24x0,5
5DL06	128	32	23,2	13,7
5DL07	120	34	23,2	13,7
5DL08	111	34	23,2	13,7
5DL09	108	21	10	12,5x24x0,5
5DL10	105	28	12,2	-
5DL11	75	19	-	-
5DL12	92	11	-	-
5DL13	118	51	28,5	13,9
5DL14	115	24	13,4	12,5x23x0,5
5DN03	83	19,6	-	M10 x 1,25
5DN04	74,5	22,3	-	13,5x25x0,5
5DN06	74,5	22,3	-	13,5x25x0,5
5DN07	83	19,2	-	M10 x 1,25
5DN09	84	30	-	8,9
5DN10	85,5	29	-	8,9
5DN11	83	31,6	-	M10 x 1,25
5DN13	105	39	19,4	13,5x25x0,5
5DN14	135	34,5	18	M10 x 1,25
5DN17	93,5	24,9	16,8	13,5x25x0,5
5DN18	93,5	23,2	15,7	M10 x 1,25
5DN19	94	38	-	8,9
5DN20	102	32	16,5	13,5x25
5DN21	88	20,3	12,2	13,5x25
5DN22	94	21,7	13,9	13,5x25
5DN25	102	30	12	M10 x 1,25
5DN27	84	27,5	18	-
5DN28	96	37	-	M10 x 1,25
5DN29	98	23,7	12,5	M10 x 1,25
5DN30	110	37	-	M10 x 1,25
5DN31	98	24	12,5	13,5x25x0,5
5DN32	104	35,5	-	M10 x 1,25
5DN35	89	33,5	-	M10 x 1,25
5FS01	122	31	15,7	13,6x21x0,6
5FS02	122	31	21,3	13,6x21x0,6
5FS03	122	28	17	13,6x21x0,6
5HA01	105	34,8	15,4	13,6x21x0,6
5HA02	109,5	37	20	13,6x21x0,6
5HA03	105	37	20	13,6x21x0,6
5HA04	110	38	21	13,6x21x0,6
5HA07	98,5	24,5	14	13,6x21x0,6
5HA08	100	34	16,6	13,6x21x0,6
5HA09	109	38,9	18,8	13,2x21x0,5
5KE01	102	20	6,1	9,5x18x0,5
5MI01	94	14	1,6	9,5x18x0,5

# CLUTCH HUBS

Tarcze sprzęgła - tabela

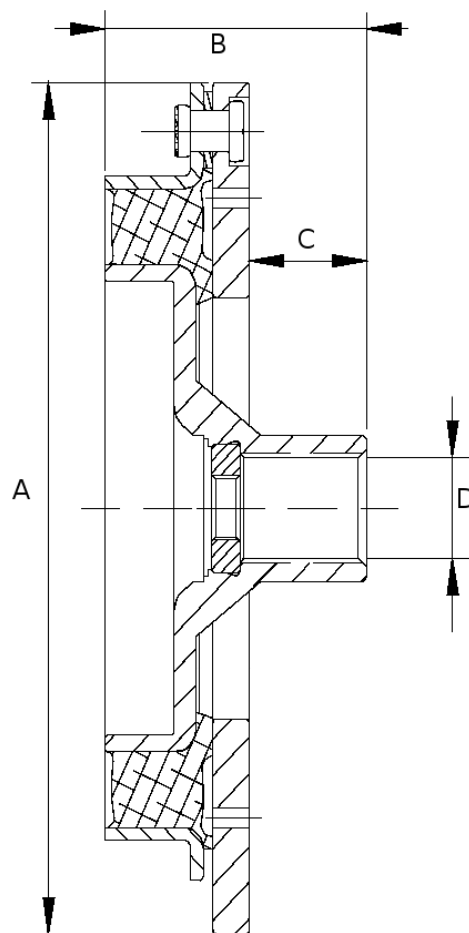

- A- magnetic slot (Średnica całkowita)
- B- height (Wysokość całkowita)
- C- face height (Wysokość mocowania)
- D- assembly (Rodzaj mocowania)

	A	B	C	D
5MI03	92	11,5	2,8	17x9,5
5MI04	92	14	3	18x9,5
5PA01	109,5	47	30,2	12,5x23x0,5
5PA02	102	47	30,2	12,5x23x0,5
5PA03	95	50	34	12,5x23x0,5
5PA04	109,5	35,5	18,5	13,5x25
5PA05	104,3	27	10,3	-
5PA06	110	27	10	12,5x23x0,5
5PA07	95	23,5	10,8	12,5x23x0,5
5SC01	107,4	18	5	17 (-1) 9,55
5SD01	106	28	5,5	13x24x0,5
5SD02	91	26	16	13x24x0,5
5SD03	105	27,7	10	11,5x22x0,5
5SD04	105	28	14	11,5x22x0,5
5SD05	105	27	14	11,5x22x0,5
5SD06	105	30,2	13	11,5x22x0,5
5SD07	90	21	11,5	12,51x23
5SD08	90,5	26	16,2	13x24x0,5
5SD09	110,5	32,2	15	12,9
5SD10	105	32	14,8	13x24
5SD11	106	22,1	12,9	12,9
5SD12	105	17	4,4	9,5x18
5SD13	105	18,8	6	9,5x18
5SD14	105	18	8,9	11,50x22
5SD15	105	22,7	10,3	13,2X24
5SD17	105	28	13	11,5x22x0,5
5SD18	105	20	10	13x23(-1)x0,5
5SD19	102	31	13,5	11,5x22x0,5
5SS01	103,7	32,8	19	12,5x23
5SS02	109	41	24	12x23
5VI01	116	38,2	21	13,5x21x0,5
5VI02	115	36,9	20	13,5x21x0,5
5VI03	110	40	21	13,5x21x0,5
5VI04	115	41	23	13,5x21x0,5
5VI05	87	25,5	13,9	13x24x0,5
5VI06	115	40	21,3	13,5x21x0,5
5YO01	134	45	34	21
5ZX01	92	22,5	-	13,5x26x0,5
5ZX02	85,5	22	4	13,5x26x0,5
5ZX03	112,2	32,5	16	13,5x25x0,5
5ZX04	112	22	9	13,5x26x0,5
5ZX05	112,2	32,5	16	13,5x25x0,5
5ZX06	111	36,4	24	13,5x26x0,5
5ZX06	110	18	6,3	13,5x26x0,5
5ZX07	110	18	6,5	13,5x36x0,5
5ZX08	92	22,5	11,5	12,5x23x0,5
5ZX09	100	21	12,3	-
5ZX10	140	41,4	24	17x33x0,5
5ZX11	92	21	12	12,5x23x0,5
5ZX12	95	25	12,2	12,5x23x0,5
5ZX13	105,3	25	7,9	13,5x26x0,5
5ZX14	150	43	27	20x38x0,5
5ZX15	185	58	35	24x30x0,5

# CLUTCH HUBS

Tarcze sprzęgła - tabela

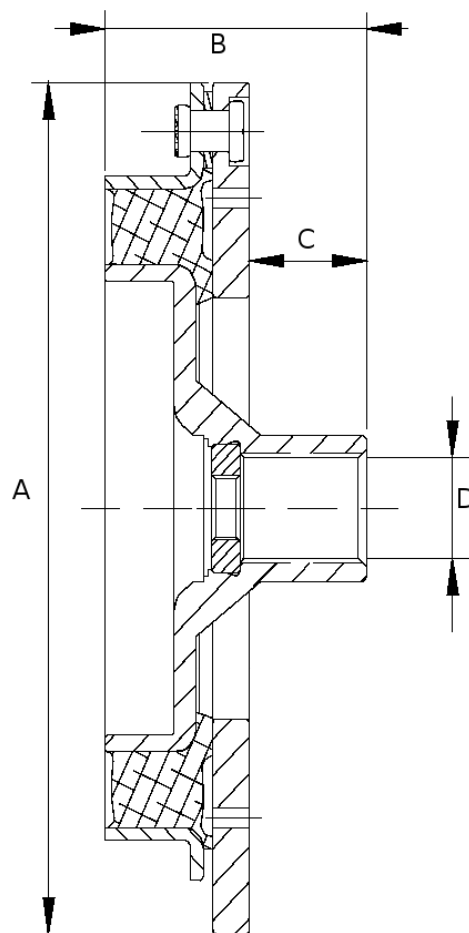

- A- magnetic slot (Średnica całkowita)
- B- height (Wysokość całkowita)
- C- face height (Wysokość mocowania)
- D- assembly (Rodzaj mocowania)

**CALSONIC** **6CL01**



Ø 110/110mm  
 12V  
 CVC/  
 CSV717

**BMW**

035x52x20 4CL01 5CL01

**CALSONIC** **6CL02**



Ø 129/124mm  
 12V  
 CWV615M

**NISSAN**

035x55x20 4ZX05 5CL04

**CALSONIC** **6CL03**



Ø 129/124mm  
 12V  
 CWV615M

**NISSAN**

035x55x20 4CL03 5CL03

**CALSONIC** **6CL04**



Ø 119/115mm  
 12V

**NISSAN**

035x55x20 4ZX05 5ZX07

**CALSONIC** **6CL05**



Ø 109/109mm  
 12V  
 CSE717

**BMW**

035x50x20 n/a 5CL05

**CALSONIC** **6CL06**



Ø 139/135mm  
 12V

**NISSAN**

035x55x20 4CL03 5CL02

**CALSONIC** **6CL07**



Ø 119/114mm  
 12V  
 CSV617

**NISSAN**

035x50x20 4CL08

**CALSONIC** **6CL08**



Ø 129/125mm  
 12V  
 CR-12SC

**RENAULT**

035x55x20

**CALSONIC** **6CL09**



Ø 114/110mm  
 12V  
 CR10

**NISSAN**

035x55x20

**CALSONIC** **6CL10**



Ø 110/110mm  
 12V  
 CSE717

**BMW**

035x55x20 4CL01 5CL01

**CALSONIC** **6CL11**



Ø 110/110mm  
 12V  
 CSE717

**BMW**

035x55x20 4CL01 5CL01

**CALSONIC** **6CL12** NEW!!! v.01



Ø 110/110mm  
 12V  
 CWV717/  
 CSE717

**BMW**

035x55x20 4CL01 5CL01

**CALSONIC** **6CL13** NEW!!! v.01



Ø 119/114mm  
 12V  
 CR-12S

**NISSAN**

035x55x20

**CALSONIC** **6CL14** NEW!!! v.01



Ø 104/100mm  
 12V  
 CR08

**NISSAN**

030x47x18 4ZX10

**CALSONIC** **6CL15** NEW!!! v.01



Ø 115/110mm  
 12V  
 CSE613C

**BMW**

035x52x20 n/a

**DELPHI** **6DL01**



Ø 109/105mm  
 12V  
 CVC

**OPEL**

035x50x20 4DL01 5DL02

**DELPHI** **6DL02**



Ø 129/125mm  
 12V  
 CVC

**RENAULT/NISSAN**

035x55x20 4DL05 5DL04

**DELPHI** **6DL03**



Ø 109/105mm  
 12V  
 CVC

**OPEL**

035x52x20 n/a

**DELPHI** **6DL04**



Ø 109/105mm  
 V6  
 12V  
 CVC

**OPEL**

Ø35x52x20 n/a

**DELPHI** **6DL05**



Ø 128mm  
 V6  
 12V  
 V5

**OPEL**

Ø40x62x20,6 4DL02

**DELPHI** **6DL06**



Ø 124/119mm  
 V6  
 12V  
 V5

**OPEL**

Ø40x62x20,6 4DL02 5DL07

**DELPHI** **6DL07**



Ø 115/110mm  
 V6  
 12V  
 DH5

**AUDI/SEAT/SKODA/VW**

Ø35x55x20 n/a 5DL03

**DELPHI** **6DL08**



Ø 122/118mm  
 V7  
 12V  
 CVC

**RENAULT/NISSAN**

Ø35x55x20 4DL05 5DL04

**DELPHI** **6DL09**



Ø 129/125mm  
 V6  
 12V  
 V5

**OPEL**

Ø40x62x20 5DL08

**DELPHI** **6DL10**



Ø 125/121mm  
 V6  
 12V  
 SP17

**CHEVROLET**

Ø35x52x22 4DL10 5DL09

**DELPHI** **6DL11**



Ø 126/122mm  
 V6  
 12V  
 10S

**CHEVROLET**

Ø30x52x22 4DN01 5DN13

**DELPHI** **6DL12**



Ø 126/122mm  
 V6  
 12V

**CHEVROLET**

Ø35x52x22

**DELPHI** **6DL13**



Ø 103/94mm  
 V6  
 12V  
 GM QS90

**OPEL**

Ø32x47x18 4DL12 5DL12

**DELPHI** **6DL14**



Ø 123/119mm  
 V7  
 12V  
 V5

**RENAULT**

Ø40x62x20,6

**DELPHI** **6DL15**



Ø 109/104mm  
 V5  
 12V  
 CVC

**OPEL**

Ø35x50x20 4DL01 5DL02

**DELPHI** **6DL16**



Ø 110mm  
 V5  
 12V  
 CVC/  
 GM0274

**OPEL/CHEVROLET**

Ø35x52x20 4DL11 5DL10

**DELPHI** **6DL17**



Ø 124/119mm  
 V6  
 12V  
 HD6/DA6

**BUICK/RENAULT**

Ø40x62x20,6 4DL03 5DL07

**DELPHI** **6DL18**



Ø 113/110mm  
 V6  
 12V  
 DH5

**AUDI/SEAT/SKODA/VW**

Ø35x55x20 n/a 5DL11

**DELPHI** **6DL19**



Ø 114/110mm  
 V6  
 12V

**OPEL/CHEVROLET**

Ø35x52x20

**DELPHI** **6DL20**



Ø 105mm  
 V6  
 12V  
 CVC

**OPEL**

Ø35x50x20 4DL01 5DL14

**DELPHI** **6DL21**



Ø 132mm  
 2A  
 24V  
 V5

**SPEC.VEH.**

Ø40x62x20,6 4DL20



**DELPHI** *NEW!!! v.01* **6DL22**



Ø 125/121mm  
 V6  
 12V  
 V5

**RENAULT**

040x62x20,6 04DL03

**DENSO** **6DN01**



Ø 114/109mm  
 V4  
 12V  
 6SE/7SE

**AUDI**

035x52x22 0n/a 05DN04/1

**DENSO** **6DN02**



Ø 119/ mm  
 N/A  
 12V  
 7SEU17C

**VW**

035x52x22 0n/a 05DN04/1

**DENSO** **6DN03**



Ø 126/120mm  
 V4  
 12V  
 7SBU16C

**AUDI/SEAT/SKODA/VW**

035x52x22 04DN02 05DN13

**DENSO** **6DN04**



Ø 116/110mm  
 V5  
 12V  
 6SEU12C

**MERCEDES**

035x52x22 0n/a 05DN06/5

**DENSO** **6DN05**



Ø 105/100mm  
 V8  
 12V  
 7SEU17C

**AUDI/MERCEDES**

035x52x12 0n/a 05DN03/2

**DENSO** **6DN06**



Ø 105/100mm  
 V6  
 12V  
 5SE12C

**MERCEDES**

035x52x12 0n/a 05DN03/2

**DENSO** **6DN07**



Ø 105/100mm  
 V5  
 12V  
 5SE/6SE

**TOYOTA**

035x52x12 0n/a 05DN02/1

**DENSO** **6DN08**



Ø 125/120mm  
 V6  
 12V  
 5SEU12C/  
 6SEU14C

**TOYOTA**

035x52x12 0n/a 05DN02/1

**DENSO** **6DN09**



Ø 120/115mm  
 V6  
 12V  
 5SE09

**TOYOTA**

035x52x12 0n/a 05DN07/8

**DENSO** **6DN10**



Ø 116/110mm  
 V6  
 12V  
 7SEU16C

**MERCEDES**

035x52x22 0n/a 05DN03/2

**DENSO** **6DN11**



Ø 100/100mm  
 V4  
 12V  
 7SEU17C

**BMW**

035x52x12 0n/a 05DN03/2

**DENSO** **6DN12**



Ø 120/115mm  
 V6  
 12V  
 6SE/7SE

**AUDI**

035x52x22 0n/a 05DN03/2

**DENSO** **6DN13**



Ø 105/100mm  
 V6  
 12V  
 6SE/7SE

**AUDI**

035x52x22 0n/a 05DN03/2

**DENSO** **6DN14**



Ø 110/110mm  
 V4  
 12V  
 6SEU12C

**AUDI**

035x52x22 0n/a 05DN04/1

**DENSO** **6DN15**



Ø 105/100mm  
 V6  
 12V  
 6SEU14C

**AUDI/VW**

035x52x20 0n/a 05DN09

**DENSO** **6DN16**



Ø 105/100mm  
 V7  
 12V  
 6SE/7SE

**MERCEDES**

035x52x20 0n/a 05DN10

**DENSO** **6DN17**



Ø 125mm  
 V6  
 12V

**TOYOTA**

035x52x12 0n/a 05DN11/2

**DENSO** **6DN18**  
  
 Ø 130mm  
 V6  
 12V  
**MERCEDES**  
 35x52x22 n/a 5DN03/2

**DENSO** **6DN19**  
  
 Ø 115/110mm  
 V6  
 12V  
 5SE12C/  
 5SL12C  
**OPEL/FIAT**  
 35x52x22 n/a 5DN03/2

**DENSO** **6DN20**  
  
 Ø 124/120mm  
 V7  
 12V  
 6SEU14C  
**MERCEDES**  
 35x52x22 n/a 5DN03/2

**DENSO** **6DN21**  
  
 Ø 105/100mm  
 V6  
 12V  
 5SE09C  
**TOYOTA**  
 35x52x12 n/a 5DN11/2

**DENSO** **6DN22**  
  
 Ø 115/109mm  
 V4  
 12V  
 10PA17C/  
 10S17C  
**IVECO**  
 30x52x22 4DN01 5DN13

**DENSO** **6DN23**  
  
 Ø 135/130mm  
 V7  
 12V  
 10S17C  
**HONDA**  
 30x52x22 4DN05 5DN20

**DENSO** **6DN24**  
  
 Ø 115/110mm  
 V7  
 12V  
 5SE12C  
**TOYOTA**  
 35x52x12 n/a 5DN02/1

**DENSO** **6DN25**  
  
 Ø 115/110mm  
 V5  
 12V  
 5SE12  
**FIAT/GM/OPEL**  
 35x52x22 n/a 5DN11/2

**DENSO** **6DN26**  
  
 Ø 115/110mm  
 V5  
 12V  
 6SEU16  
**MERCEDES**  
 35x52x12 n/a 5DN03/2

**DENSO** **6DN27**  
  
 Ø 110mm  
 V6  
 12V  
 7SEU17C  
**BMW**  
 35x52x12 n/a 5DN07/3

**DENSO** **6DN28**  
  
 Ø 130/125mm  
 V6  
 12V  
 6SE/7SEU/  
 6SEL14C  
**RENAULT/PSA**  
 35x52x20 n/a 5DN03/2

**DENSO** **6DN29**  
  
 Ø 110/110mm  
 V7  
 12V  
 6SEU14C  
**BMW**  
 35x52x12 n/a 5DN07/3

**DENSO** **6DN30**  
  
 Ø 115/110mm  
 V6  
 12V  
 6SE/7SE  
**MERCEDES**  
 35x52x12 n/a 5DN03/2

**DENSO** **6DN31**  
  
 Ø 125/120mm  
 V6  
 12V  
 5SE/6SEU  
**TOYOTA**  
 35x52x12 n/a 5DN11/2

**DENSO** **6DN32**  
  
 Ø 115/110mm  
 V6  
 12V  
 6SEU12C  
**VW**  
 35x52x20 n/a 5DN03/2

**DENSO** **6DN33**  
  
 Ø 115/110mm  
 V6  
 12V  
 5SL12C  
**OPEL**  
 35x52x22 n/a 5DN04/1

**DENSO** **6DN34**  
  
 Ø 125/121mm  
 V4  
 12V  
 5SE/6SE  
**TOYOTA**  
 35x52x12 n/a 5DN03/2

**DENSO** **6DN35**  
  
 Ø 132/110mm  
 V7  
 12V  
 6SEU16C  
**TOYOTA**  
 35x52x12 n/a 5DN14



**DENSO** **6DN36**  
  
 Ø 125/119mm  
 V6  
 12V  
 6SEU/7SEU  
**MERCEDES**  
 35x52x20 n/a 5DN10

**DENSO** **6DN37**  
  
 Ø 115/110mm  
 V6  
 12V  
 6SE/7SE  
**AUDI/SEAT/SKODA/VW**  
 35x52x20 n/a 5DN09

**DENSO** **6DN38**  
  
 Ø 105/100mm  
 V5  
 12V  
 6SEU16C  
**MERCEDES**  
 35x52x12 n/a 5DN03/2

**DENSO** **6DN39**  
  
 Ø 109/105mm  
 V6  
 12V  
 SCS06D  
**FIAT/TOYOTA**  
 35x52x20 4DN07 5DN22

**DENSO** **6DN40**  
  
 Ø 120/115mm  
 V6  
 12V  
 6SE/7SE  
**AUDI/MERCEDES**  
 35x52x22 n/a 5DN10

**DENSO** **6DN41**  
  
 Ø 120mm  
 V6  
 12V  
 10PA  
**CHRYSLER**  
 30x52x22 4DN01 5DN13

**DENSO** **6DN42**  
  
 Ø 126/121mm  
 V6  
 12V  
 7SB16C/  
 7SB17C  
**MERCEDES**  
 35x52x22 4DN01 5DN13

**DENSO** **6DN43**  
  
 Ø 126/120mm  
 V6  
 12V  
 7SBU16C  
**AUDI/VW**  
 35x52x22 4DN01 5DN13

**DENSO** **6DN44**  
  
 Ø 125/120mm  
 V6  
 12V  
 7SEU17C  
**MERCEDES**  
 35x52x12 n/a 5DN03/2

**DENSO** **6DN45**  
  
 Ø 115/110mm  
 V6  
 12V  
 7SEU17C  
**MERCEDES**  
 35x52x20 n/a 5DN10

**DENSO** **6DN46**  
  
 Ø 100/100mm  
 V7  
 12V  
 7SEU17C  
**MERCEDES**  
 35x52x12 n/a 5DN03/2

**DENSO** **6DN47**  
  
 Ø 125/120mm  
 V6  
 12V  
 10S15M/10S17C/  
 10S20C  
**CHRYSLER**  
 30x52x22 4DN01 5DN13

**DENSO** **6DN48**  
  
 Ø 100/100mm  
 V6  
 12V  
 5SE12C  
**BMW**  
 35x52x12 n/a 5DN03/1

**DENSO** **6DN49**  
  
 Ø 120/115mm  
 V6  
 12V  
 SCS08  
**FIAT/TOYOTA**  
 35x52x20 4DN07 5DN02

**DENSO** **6DN50**  
  
 Ø 135/130mm  
 V7  
 12V  
 5SE12C  
**TOYOTA/LEXUS**  
 35x52x12 n/a 5DN11/2

**DENSO** **6DN51**  
  
 Ø 120/115mm  
 V7  
 12V  
 7SEU16C  
**AUDI/PORSCHE/VW**  
 35x52x22 n/a 5DN04/1

**DENSO** **6DN52**  
  
 Ø 125/120mm  
 V7  
 12V  
 7SEU17C  
**AUDI/VW**  
 35x52x22 n/a 5DN04/1

**DENSO** **6DN53**  
  
 Ø 134/130mm  
 V6  
 12V  
 5SSL12C-J/  
 SCSA  
**FIAT/TOYOTA**  
 35x52x20 4DN07 5DN22



**DENSO** **6DN54**  

 Ø 115/110mm  
 V6  
 12V  
 6SE/7SE  
**AUDI/SEAT/SKODA/VW**  
 35x52x22 n/a 5DN06/5

**DENSO** **6DN55**  

 Ø 108/103mm  
 V6  
 12V  
**MERCEDES**  
 35x52x22 n/a 5DN04/1

**DENSO** **6DN56**  

 Ø 135/130mm  
 V9  
 24V  
 10PA  
**MERCEDES**  
 35x52x22 4DN20 5DN13

**DENSO** **6DN57**  

 Ø 142 mm  
 1A  
 24V  
**ISUZU**  
 30x52x22 4DN20 5DN13

**DENSO** **6DN58**  

 Ø 110/110mm  
 V4  
 12V  
 7SEU17C  
**BMW**  
 35x52x12 n/a 5DN03/2

**DENSO** **6DN59**  

 Ø 125/120mm  
 V4  
 12V  
 10S13  
**SUZUKI**  
 30x52x22 5DN20

**DENSO** **6DN60**  

 Ø 130/126mm  
 V6  
 12V  
 6SEU  
**AUDI**  
 35x52x20 4DN05 5DN09

**DENSO** **6DN61**  

 Ø 135/130mm  
 V11  
 24V  
 7SBU16C  
**MERCEDES**  
 35x52x22 4DN20 5DN13

**DENSO** **6DN62**  

 Ø 116/110mm  
 V6  
 12V  
 7SEU17C  
**BMW**  
 35x52x12 5DN07/3

**DENSO** **6DN63**  

 Ø 116/110mm  
 V6  
 12V  
 7SEU17C  
**BMW**  
 35x52x12 n/a 5DN07/3

**DENSO** **6DN64**  

 Ø 115/110mm  
 V8  
 12V  
 7SEU  
**BMW**  
 35x52x22 n/a 5DN07/3

**DENSO** **6DN65**  

 Ø 105/100mm  
 V6  
 12V  
 7SEU17C  
**BMW**  
 35x52x12 n/a 5DN07/3

**DENSO** **6DN66**  

 Ø 144/140mm  
 V8  
 24V  
 10S15/17  
**CATERPILLAR**  
 30x52x22 4DN20 5DN13

**DENSO** **6DN67**  

 Ø 125/120mm  
 V7  
 12V  
 TSE14C  
**LEXUS/TOYOTA**  
 35x52x12 n/a 5DN19

**DENSO** **6DN68**  

 Ø 125/120mm  
 V6  
 12V  
 6SES14C  
**TOYOTA**  
 35x52x12 n/a 5DN19

**DENSO** **6DN69**  

 Ø 132mm  
 V6  
 12V  
 10PA17C  
**SPEC.VEH.**  
 30x52x22 4DN01 5DN13

**DENSO** **6DN70**  

 Ø 139 mm  
 1A  
 24V  
 10S17C  
**SPEC.VEH.**  
 30x52x22 4DN20 5DN13

**DENSO** **6DN71**  

 Ø 120/116mm  
 V6  
 12V  
 SCS  
**TOYOTA/FIAT**  
 35x52x20 4DN07 5DN22

**DENSO** **6DN72**  

 Ø 136/130mm  
 V6  
 12V

**HONDA**  
 30x52x22 4DN06 5DN13

**DENSO** **6DN73**  

 Ø 115/110mm  
 V6  
 12V  
 6SEU

**AUDI/VW**  
 35x52x22 n/a 5DN01/4

**DENSO** **6DN74**  

 Ø 115/110mm  
 V6  
 12V  
 6SEU

**MERCEDES**  
 35x52x22 n/a 5DN03/2

**DENSO** **6DN75**  

 Ø 145/139mm  
 V8  
 12V  
 10PA

**JOHNDEERE**  
 30x52x22 4DN01 5DN13

**DENSO** **6DN76**  

 Ø 86 mm  
 N/A  
 12V  
 7SEU17C

**AUDI/VW/LAMBORGHINI**  
 35x52x12 n/a 5DN23/4

**DENSO** **6DN77**  

 Ø 125/120mm  
 V7  
 12V  
 6SEU16C

**MERCEDES/DENSO**  
 35x52x22 n/a 5DN04/1

**DENSO** **6DN78**  

 Ø 124/120mm  
 V7  
 12V  
 10S11C

**TOYOTA/HILUX**  
 30x52x20 4DN07 5DN22

**DENSO** **6DN79**  

 Ø 97/93mm  
 V6  
 12V  
 SCSA06

**TOYOTA/FIAT**  
 30x47x20 4DN04 5DN21

**DENSO** **6DN80**  

 Ø 105/100mm  
 V6  
 12V  
 5SE

**MERCEDES**  
 35x52x22 n/a 5DN03/2

**DENSO** **6DN81**  

 Ø 115/110mm  
 V6  
 12V

**MERCEDES**  
 35x52x22 n/a 5DN10

**DENSO** **6DN82**  

 Ø 125/120mm  
 V4  
 12V

**IVECO**  
 30x52x22 4DN01 5DN13

**DENSO** **6DN83**  

 Ø 125/120mm  
 V4  
 12V

**IVECO**  
 30x52x22 4DN01 5DN13

**DENSO** **6DN85**  

 Ø 105mm  
 V6  
 12V  
 7SEU16C

**MERCEDES**  
 35x52x22 n/a 5DN04/1

**DENSO** **6DN86**  

 Ø 103mm  
 V7  
 12V  
 7SEU16C

**MERCEDES**  
 35x52x22 n/a 5DN04/1

**DENSO** **6DN87**  

 Ø 105/100mm  
 V6  
 12V  
 7SEU17C

**VWT5**  
 35x52x20 n/a 5DN09

**DENSO** **6DN88**  

 Ø 135/130mm  
 V6  
 12V  
 10S20H

**CHRYSLER/DODGE**  
 30x52x22 4DN01 5SD06

**DENSO** **6DN89**  

 Ø 116mm  
 V5  
 12V  
 6SES14C

**MERCEDES**  
 35x52x22 n/a 5DN10

**DENSO** **6DN90**  

 Ø 114/110mm  
 V6  
 12V

**MITSUBISHI**  
 30x52x22 4HA08 5HA01



**DENSO** **6DN91**  

 Ø 115/110mm  
 12V  
 10SR17C  
**CHRYSLER/DODGE**  
 30x52x22 4DN01 5DN13

**DENSO** **6DN92**  

 Ø 124/119mm  
 12V  
 5SEL12C  
**PEUGEOT/CITROEN**  
 35x52x12 n/a 5DN03/2

**DENSO** **6DN93**  

 Ø 114/109mm  
 12V  
 6SES14C  
**AUDI/VW**  
 35x52x20 n/a 5DN27

**DENSO** **6DN94**  

 Ø 100mm  
 12V  
 5SE12C  
**CHRYSLER/DODGE/JEEP**  
 35x52x22 n/a 5DN04/1

**DENSO** **6DN95**  

 Ø 124mm  
 12V  
 10PA15C  
**SPEC. VEH./JOHNDEER**  
 30x52x22 4DN01 5DN13

**DENSO** **6DN96**  

 Ø 147mm  
 1A  
 12V  
 10PA15C/  
 10S15C  
**SPEC. VEH./JOHNDEER**  
 30x52x22 4DN01 5DN13

**DENSO** **6DN97**  

 Ø 146mm  
 1A  
 12V  
 10PA  
**SPEC. VEH./JOHNDEER**  
 30x52x22 4DN01 5DN13

**DENSO** **6DN98**  

 Ø 146mm  
 1A  
 12V  
 10PA17C  
**SPEC. VEH./JOHNDEER**  
 30x52x22 4DN01 5DN13

**DENSO** **6DN99**  

 Ø 120mm  
 1A  
 12V  
 10PA17C  
**SPEC. VEH./JOHNDEER**  
 30x52x22 4DN01 5DN13

**DENSO** **6DN100**  

 Ø 146mm  
 1A  
 12V  
 6E171  
**SPEC. VEH./JOHNDEER**  
 40x62x24

**DENSO** **6DN101**  

 Ø 152mm  
 1A  
 12V  
 5S15C  
**SPEC. VEH./JOHNDEER**  
 30x52x22 4DN01 5DN13

**DENSO** **6DN102**  

 Ø 146mm  
 1A  
 12V  
 10PA  
**SPEC. VEH./JOHNDEER**  
 30x52x22 4DN01 5DN13

**DENSO** **6DN103**  

 Ø 135mm  
 12A  
 24V  
 10S15C  
**SPEC. VEH.**  
 30x52x22 4DN20 5DN13

**DENSO** **6DN104**  

 Ø 135mm  
 1V4  
 24V  
 10PA15/17  
**SPEC. VEH.**  
 30x52x22 4DN01 5DN13

**DENSO** **6DN105**  

 Ø 116/112mm  
 1V4  
 12V  
 10PA17C  
**SPEC. VEH.**  
 30x52x22 4DN01 5DN13

**DENSO** **6DN106**  

 Ø 132mm  
 12A  
 12V  
 10PA15C  
**SPEC. VEH.**  
 30x52x22 4DN01 5DN13

**DENSO** **6DN107**  

 Ø 115/110mm  
 1V6  
 12V  
 6SES16C  
**LEXUS/TOYOTA**  
 35x52x12 n/a 5DN19

**DENSO** **6DN108**  

 Ø 120/115mm  
 1V7  
 12V  
 10SR15C  
**HONDA**  
 30x52x22 4DN01 5DN13



**DENSO** **6DN109**



Ø 130mm  
 12V  
 10S17

**TOYOTA**

30x52x22    4DN05    5DN20

**DENSO** **6DN110**



Ø 110mm  
 12V  
 6SEU12C

**MERCEDES**

35x52x20    n/a    5DN06/5

**DENSO** **6DN111**



Ø 130mm  
 12V  
 10S17C

**CHRYSLER**

30x52x22    4DN01    5DN13

**DENSO** **6DN112**



Ø 115/110mm  
 12V  
 5TSE10C

**TOYOTA**

35x52x12    n/a    5DN28

**DENSO** **6DN113**



Ø 115/110mm  
 12V  
 6SAS14C

**AUDI**

35x52x20    4DN11    5DN29

**DENSO** **6DN114**



Ø 125/120mm  
 12V  
 10S17C

**CHRYSLER/MERCEDES**

30x52x22    4DN01    5DN13

**DENSO** **6DN115**



Ø 115/110mm  
 12V  
 5TSE10C

**TOYOTA**

35x52x12    n/a    5DN30

**DENSO** **6DN116**



Ø 115/110mm  
 12V

**TOYOTA**

35x52x22    n/a    5DN01/4

**DENSO** **6DN117**



Ø 115/110mm  
 12V  
 5SE12C

**TOYOTA**

35x52x12    n/a    5DN02/1

**DENSO** **6DN118**



Ø 105/100mm  
 12V  
 5SE09C

**MITSUBISHI/SMART**

35x52x12    n/a    5DN03/2

**DENSO** **6DN119**



Ø 115/110mm  
 12V  
 6SBU16C

**VW T5**

35x52x20    n/a    5DN09

**DENSO** **6DN120**



Ø 115/110mm  
 12V  
 5SE12C

**FIAT/OPEL/SUZUKI**

35x52x22    n/a    5DN11/2

**DENSO** **6DN121**



Ø 110/110mm  
 12V  
 7SEU17C

**BMW**

35x52x12    n/a    5DN07/8

**DENSO** **6DN122**



Ø 110mm  
 12V  
 7SE

**AUDI/PORSCHE/VW**

35x52x20    n/a    5DN09

**DENSO** **6DN123**



Ø 120/115mm  
 12V  
 6SAS14C/  
 7SAS17C

**MERCEDES/NISSAN**

35x52x20    n/a    5DN10

**DENSO** **6DN124**



Ø 125/120mm  
 12V  
 7SBU16C

**OPEL**

30x52x22    4DN01    5DN13

**DENSO** **6DN125**



Ø 126mm  
 12V  
 6SE/7SEU

**AUDI**

35x52x22    n/a    5DN03/2

**DENSO** **6DN126**



Ø 124/119mm  
 12V  
 6SEL14C

**RENAULT**

35x52x20    n/a    5DN03/2

**DENSO** *NEW!!! v. 01* **6DN127**  
  
 Ø 120/115mm  
 12V  
 6SES  
**MERCEDES**  
 035x52x20 0n/a 5DN10

**DENSO** *NEW!!! v. 01* **6DN128**  
  
 Ø 115/110mm  
 12V  
 5TSE10C  
**TOYOTA**  
 035x52x12 0n/a 5DN19

**DENSO** *NEW!!! v. 01* **6DN129**  
  
 Ø 115/110mm  
 12V  
 6SEU16C/  
 7SES17C  
**MERCEDES**  
 035x52x20 0n/a 5DN09

**DENSO** *NEW!!! v. 01* **6DN130**  
  
 Ø 122/115mm  
 12V  
 6SEU14C/  
 6SEU16C  
**AUDI/MERCEDES**  
 035x52x20 0n/a 5DN09

**DENSO** *NEW!!! v. 01* **6DN131**  
  
 Ø 113/109mm  
 12V  
 7SBU17C  
**BMW**  
 035x52x22 04DN06 5DN20

**DENSO** *NEW!!! v. 01* **6DN132**  
  
 Ø 114/110mm  
 12V  
 DKV8/DKV10R/  
 SCSA06/SCSB06  
**FIAT/SUBARU/TOYOTA**  
 032x47x18 04ZX10 5DN22

**DENSO** *NEW!!! v. 01* **6DN133**  
  
 Ø 136/mm  
 12V  
 10S17C  
**MITSUBISHI**  
 030x52x22 04DN01 5DN13

**DENSO** *NEW!!! v. 01* **6DN134**  
  
 Ø 121/117mm  
 12V  
 10PA17C  
**KIA**  
 030x52x22 04DN08 5DN13

**DENSO** *NEW!!! v. 01* **6DN135**  
  
 Ø 125/119mm  
 12V  
 10SRE/10S15/  
 10S17/10S20  
**HONDA**  
 030x52x22 04DN06 5DN20

**DENSO** *NEW!!! v. 01* **6DN137**  
  
 Ø 116/110mm  
 12V  
 7SEU17C  
**LANDROVER**  
 035x52x12 0n/a 5DN07/3

**DENSO** *NEW!!! v. 01* **6DN138**  
  
 Ø 115/110mm  
 12V  
 6SEU16C/  
 7SES17C  
**MERCEDES**  
 035x52x20 0n/a 5DN09

**DENSO** *NEW!!! v. 01* **6DN139**  
  
 Ø 124/119mm  
 12V  
 5SEL12C/  
 6SEL16C  
**CITROEN/PEUGEOT**  
 035x52x12 0n/a 5DN03/2

**DENSO** *NEW!!! v. 01* **6DN143**  
  
 Ø 114/110mm  
 12V  
 6SBU16C/  
 7SBU17A  
**MERCEDES**  
 035x55x22 0 5DN25

**DENSO** *NEW!!! v. 01* **6DN144**  
  
 Ø 114/110mm  
 12V  
 6SBU16C/  
 7SBU17A  
**MERCEDES**  
 035x55x22 0 5DN25

**FORD FS** **6FS01**  
  
 Ø 131/127mm  
 12V  
 FS10  
**FORD**  
 030x55x23 04FS03 0

**FORD FS** **6FS02**  
  
 Ø 125/115mm  
 12V  
 FS10  
**FORD**  
 030x55x23 04FS01 0

**HALLA** **6HA01**  
  
 Ø 124/120mm  
 12V  
 HS-18  
**KIA/HYUNDAI**  
 035x52x20 04HA02 5HA03

**HALLA** **6HA02**  
  
 Ø 128/124mm  
 12V  
 HS-15  
**HYUNDAI**  
 035x52x20 04HA02 5HA01



**HALLA** **6HA03**



Ø 127/123mm  
 12V  
 HS-18

**KIA/HYUNDAI**

30x55x23 4HA01 5HA04

**HALLA** **6HA04**



Ø 127/124mm  
 12V  
 HS-18

**KIA/HYUNDAI**

30x55x23 4HA01 5HA04

**HALLA** **6HA05**



Ø 115/110mm  
 12V  
 HS-16/  
 HS-18

**KIA/HYUNDAI**

35x52x12 n/a 5HA05/6

**HALLA** **6HA06**



Ø 130/124mm  
 12V  
 10PA

**KIA**

30x52x22 4DN08 5DN13

**HALLA** **6HA07**



Ø 127/123mm  
 12V  
 10PA

**KIA**

30x52x22 4DN08 5DN13

**HALLA** **6HA08**



Ø 128/124mm  
 12V  
 10PA

**KIA**

30x52x22 4DN08 5DN13

**HALLA** **6HA09**



Ø 143/139mm  
 12V

**HYUNDAI**

30x55x23 4HA04 5HA02

**HALLA** **6HA10**



Ø 125/121mm  
 12V

**HYUNDAI**

30x55x23 4HA04 5HA02

**HALLA** **6HA11**



Ø 128/124mm  
 12V  
 6SEU16C

**KIA**

35x52x22 4DN08 5DN13

**HALLA** **6HA12**



Ø 128/124mm  
 12V  
 HS-15/  
 HS-18

**HYUNDAI/KIA**

30x55x23 4HA01 5HA04

**HALLA** **6HA13**



Ø 122/118mm  
 12V  
 HS-18

**HYUNDAI/KIA**

30x52x22 4HA01 5HA03

**HALLA** **6HA14**



Ø 126/123mm  
 12V  
 HS

**HYUNDAI/KIA**

30x52x22 4HA08 5DN13

**HALLA** **6HA15**



Ø 142 mm  
 12V  
 HS-15

**FORD**

30x55x23 4HA01 5HA09

**HALLA** **6HA16**



Ø 115mm  
 12V

**HYUNDAI/KIA**

35x52x20 n/a 5HA07

**HALLA** **6HA17**



Ø 127/123mm  
 12V  
 FS

**HYUNDAI/KIA**

35x55x20 4HA01 5HA04

**HALLA** **6HA18**



Ø 126/122mm  
 12V  
 HS-20

**HYUNDAI/HALLA**

30x52x22

**HALLA** **6HA19**



Ø 124/118mm  
 12V  
 HS-15

**FORD**

30x55x23 5HA04

**HALLA** **6HA20**



Ø 130/124mm  
 12V  
 DVE-12

**HYUNDAI/KIA**

35x52x22 n/a



**HALLA** *NEW!!! v.01* **6HA21**



Ø 120/114mm  
 1V6  
 12V  
 DVE-16

**HYUNDAI/KIA**

35x52x22    4n/a    5

**KEIHIN** **6KE01**



Ø 123/118mm  
 1V7  
 12V  
 HS110R

**HONDA**

35x50x20    4KE02    5KE01

**KEIHIN** **6KE02**



Ø 105/100mm  
 1V7  
 12V  
 HS110R/TRS

**HONDA**

35x50x20    4KE02    5KE01

**KEIHIN** **6KE03**



Ø 117/111mm  
 1V5  
 12V  
 HS-090R

**HONDA**

35x50x20    4KE04    5SD12

**KEIHIN** **6KE04**



Ø 123/118mm  
 1V7  
 12V  
 TRS

**HONDA**

35x55x20    4SD11    5KE01

**MITUBISHI** **6MI01**



Ø 102/95mm  
 1V5  
 12V  
 MSC90C

**MITSUBISHI**

35x50x20    4MI01    5MI02

**MITUBISHI** **6MI02**



Ø 115/110mm  
 1V6  
 12V  
 MSC105C/  
 MSC105CA

**MITSUBISHI**

35x50x20    4MI02    5MI02

**MITUBISHI** **6MI03**



Ø 105/100mm  
 1V6  
 12V  
 MSC90C

**MITSUBISHI**

35x50x20    4MI02    5MI02

**MITUBISHI** **6MI04**



Ø 99/95mm  
 1V6  
 12V  
 QS90

**MITSUBISHI**

32x47x18    4MI03    5MI03

**MITUBISHI** **6MI05**



Ø 102/95mm  
 1V6  
 12V  
 MSC130C/  
 MSC90

**MITSUBISHI**

35x50x20    4MI01    5MI02

**MITUBISHI** **6MI06**



Ø 90/90mm  
 1V4  
 12V  
 MSC60CAS

**SUZUKI**

35x50x20    4MI05    5MI01

**MITUBISHI** *NEW!!! v.01* **6MI07**



Ø 118/109mm  
 1V5  
 12V  
 MSC90C

**MITSUBISHI**

40x62x24    5

**PANASONIC** **6PA01**



Ø 104/100mm  
 1V5  
 12V

**MAZDA**

32x47x18    4PA04    5PA01

**PANASONIC** **6PA02**



Ø 129/125mm  
 1V6  
 12V

**MAZDA**

35x55x20    4PA02    5PA03

**PANASONIC** **6PA03**



Ø 104/100mm  
 1V6  
 12V

**MAZDA**

35x50x20    4PA04    5PA01

**PANASONIC** **6PA04**



Ø 127/125mm  
 1V8  
 12V

**MAZDA**

32x55x23    4PA02    5PA06

**PANASONIC** **6PA05**



Ø 119/114mm  
 1V5  
 12V

**MAZDA**

32x47x18    4PA04    5PA03

**PANASONIC** **6PA06**



Ø 121/117mm  
 1V6  
 12V

**MAZDA**

32x47x18    4PA05    5PA03

**PANASONIC** **6PA07**  
  
 Ø 118/115mm  
 1V5  
 12V  
 H12A  
**MAZDA**  
 32x47x18 4PA08 5PA01

**PANASONIC** **6PA08**  
  
 Ø 104/100mm  
 1V6  
 12V  
 H12A  
**MAZDA**  
 32x47x18 4PA04 5PA01

**PANASONIC** **6PA09**  
  
 Ø 109/108mm  
 1V4  
 12V  
**SUZUKI**  
 32x47x18 4MI05

**PANASONIC** **6PA10**  
  
 Ø 110/110mm  
 1V5  
 12V  
**SUZUKI**  
 32x47x18 4PA09 5PA07

**PANASONIC** **6PA11**  
  
 Ø 122/118mm  
 1V8  
 12V  
**MAZDA**  
 32x55x23 4PA07 5PA05

**SCROLL** **6SC01**  
  
 Ø 109/95mm  
 1V6  
 12V  
 SCROLL  
**FORD**  
 35x50x20 4SC01 5SC01

**SANDEN** **6SD01**  
  
 Ø 119/119mm  
 1V6  
 12V  
 SD7V16  
**AUDI/SEAT/SKODA/VW**  
 35x55x20 4SD01 5SD05

**SANDEN** **6SD02**  
  
 Ø 119/119mm  
 1V7  
 12V  
 SD7V16  
**AUDI/SEAT/SKODA/VW**  
 35x55x20 4SD08 5SD11

**SANDEN** **6SD03**  
  
 Ø 113/110mm  
 1V6  
 12V  
 PXE13/16  
**AUDI/SEAT/SKODA**  
 35x52x20 n/a 5SD01

**SANDEN** **6SD04**  
  
 Ø 126/126mm  
 1V6  
 12V  
 SD7V16  
**VW**  
 35x55x20 4SD01 5SD11

**SANDEN** **6SD05**  
  
 Ø 106/100mm  
 1V6  
 12V  
 TRS105  
**SAAB**  
 35x50x20

**SANDEN** **6SD06**  
  
 Ø 123/119mm  
 1V6  
 12V  
 SD7V16/  
 SD6V12  
**FORD/MAZDA**  
 35x55x20 4SD07 5SD04

**SANDEN** **6SD07**  
  
 Ø 124/120mm  
 1V6  
 12V  
 SD7V16  
**PEUGEOT/CITROEN**  
 35x55x20 4SD07 5SD04

**SANDEN** **6SD08**  
  
 Ø 132/ mm  
 12A  
 12V  
 SD7H15  
**SPEC.VEH.**  
 35x55x20 4SD21 5SD04

**SANDEN** **6SD09**  
  
 Ø 109/105mm  
 1V6  
 12V  
 SD6V12  
**OPEL**  
 35x50x20 4SD02 5SD04

**SANDEN** **6SD10**  
  
 Ø 113/110mm  
 1V6  
 12V  
 PXE14/16  
**AUDI/SEAT/SKODA/VW**  
 35x52x20 n/a 5SD02

**SANDEN** **6SD11**  
  
 Ø 135/131mm  
 1V8  
 24V  
 SD7H15  
**SPEC.VEH.**  
 35x55x20 4SD08 5SD04

**SANDEN** **6SD12**  
  
 Ø 123/119mm  
 1V5  
 12V  
 SD7H15  
**PEUGEOT/CITROEN**  
 35x55x20 4SD09 5SD11



**SANDEN 6SD13**  

 Ø 112/107mm  
 12V  
 TRSA09  
**HONDA**  
 035x50x20 4KE02 5SD12

**SANDEN 6SD14**  

 Ø 124/120mm  
 12V  
 PXE16/  
 PXV16  
**OPEL/SAAB**  
 035x52x20 4SD05 5SD03

**SANDEN 6SD15**  

 Ø 129/125mm  
 12V  
 SD6V12  
**RENAULT**  
 035x55x20 4SD07 5SD04

**SANDEN 6SD16**  

 Ø 111/107mm  
 12V  
 TRS  
**HONDA**  
 035x50x20 4SD19 5SD12

**SANDEN 6SD17**  

 Ø 105/99mm  
 12V  
 TRS09  
**HONDA**  
 035x52x20 4SD19 5SD12

**SANDEN 6SD18**  

 Ø 132/ mm  
 24V  
 SD7H15  
**SPEC.VEH.**  
 035x55x20 4SD21 5SD04

**SANDEN 6SD19**  

 Ø 123/119mm  
 12V  
 SD7H15  
**SPEC.VEH.**  
 035x55x20 4SD21 5SD04

**SANDEN 6SD20**  

 Ø 135/131mm  
 24V  
 SD7H15  
**VOLVO TRUCKS**  
 035x55x20 4SD21 5SD11

**SANDEN 6SD21**  

 Ø 124/120mm  
 12V  
 SD7V16  
**OPEL/SAAB**  
 035x52x20 4SD04

**SANDEN 6SD22**  

 Ø 106/100mm  
 12V  
 TRS  
**HONDA**  
 035x50x20 4SD12 5SD13

**SANDEN 6SD23**  

 Ø 117/112mm  
 12V  
 TRS  
**HONDA**  
 035x55x20 4KE03 5SD12

**SANDEN 6SD24**  

 Ø 120/115mm  
 12V  
 TRS  
**HONDA**  
 035x55x20 4KE03 5SD12

**SANDEN 6SD25**  

 Ø 132/ mm  
 12V  
 SD7H15  
**VOLVO**  
 035x55x20 4SD08 5SD11

**SANDEN 6SD26**  

 Ø 120/120mm  
 24V  
 SD7H15  
**SPEC.VEH.**  
 035x55x20 4SD08 5SD11

**SANDEN 6SD27**  

 Ø 145/140mm  
 24V  
 SD7H15  
**SPEC.VEH.**  
 035x55x20 4SD21 5SD11

**SANDEN 6SD28**  

 Ø 147/ mm  
 24V  
 SD7H15  
**SPEC.VEH.**  
 035x55x20 4SD21 5SD11

**SANDEN 6SD29**  

 Ø 110/106mm  
 12V  
 TRS  
**SPEC.VEH.**  
 035x50x20 4SD12 5SD13

**SANDEN 6SD30**  

 Ø 121/117mm  
 12V  
 SD7C16  
**CITROEN/PEUGEOT**  
 035x52x20 4SD06 5SD14





**SANDEN** **6SD31**  

 Ø 153/138mm  
 11A  
 24V  
 SD7H15  
**SPEC.VEH.**  
 35x52x20 4SD22 5SD11

**SANDEN** **6SD32**  

 Ø 152/ mm  
 12A  
 12V  
 SD7H15  
**SPEC.VEH.**  
 35x55x20 4SD08 5SD11

**SANDEN** **6SD33**  

 Ø 117/111mm  
 15V5  
 12V  
 TRS  
**HONDA**  
 35x55x20 4KE03 5SD12

**SANDEN** **6SD34**  

 Ø 123/119mm  
 18V8  
 12V  
**SPEC.VEH.**  
 35x55x20 4SD13 5SD11

**SANDEN** **6SD35**  

 Ø 120/120mm  
 18V6  
 12V  
 SD7V16  
**VW/FORD/SEAT**  
 35x55x20 4SD03 5SD11

**SANDEN** **6SD36**  

 Ø 123/123mm  
 18V1  
 24V  
 SD5H14  
**SPEC.VEH.**  
 40x62x24 4SD20

**SANDEN** **6SD37**  

 Ø 119/123mm  
 18V6  
 12V  
**VW**  
 35x52x20 5SD04

**SANDEN** **6SD38**  

 Ø 123/119mm  
 18V6  
 12V  
 SD6C12  
**CITROEN/PEUGEOT**  
 35x52x20 4SD15 5SD04

**SANDEN** **6SD39**  

 Ø 123/119mm  
 18V4  
 12V  
 SD7V16  
**CITROEN/FIAT/FORD/PEUGEOT**  
 35x55x20 4SD08 5SD11

**SANDEN** **6SD40**  

 Ø 124/120mm  
 18V5  
 12V  
 PXV  
**OPEL**  
 35x52x20 4SD05

**SANDEN** **6SD41**  

 Ø 132/ mm  
 12A  
 24V  
 SD5H14/  
 SD5H15  
**SPEC.VEH.**  
 40x62x24 4SD20

**SANDEN** **6SD43**  

 Ø 123/120mm  
 18V6  
 12V  
 PXE16  
**OPEL**  
 35x52x20 n/a 5SD08

**SANDEN** **6SD44**  

 Ø 114/110mm  
 18V3  
 12V  
 PXC16  
**VOLVO**  
 35x52x20 4SD33 5SD15

**SANDEN** **6SD45**  

 Ø 152/148mm  
 18V8  
 24V  
 SD7H15  
**SPEC.VEH./RENAULT**  
 35x55x20 4SD21 5SD04

**SANDEN** **6SD47**  

 Ø 132/ mm  
 11A  
 24V  
 SD7H15  
**SPEC.VEH./DAF**  
 35x55x20 4SD21 5SD11

**SANDEN** **6SD48**  

 Ø 140mm  
 18V8  
 24V  
 SD7H15  
**SPEC.VEH.**  
 35x55x20 4SD22 5SD11

**SANDEN** **6SD49**  

 Ø 152mm  
 12A  
 12V  
 SD7H15  
**SPEC.VEH.**  
 35x55x20 4SD23

**SANDEN** **6SD50**  

 Ø 153/133mm  
 18V8  
 12V  
 SD7H15  
**SPEC.VEH.**  
 35x55x20 4SD31

**SANDEN** **6SD51**



Ø 153/138mm  
 11A  
 24V  
 SD7H15

**SPEC.VEH.**

Ø35x55x20    4SD23    5SD15

**SANDEN** **6SD52**



Ø 106/100mm  
 1V6  
 12V  
 SD6V12

**SEAT/VOLKSWAGEN**

Ø35x55x20    4SD30    5SD17

**SANDEN** **6SD53** *NEW!!! v.01*



Ø 123/119mm  
 1V8  
 12V  
 SD5H14/  
 SD508

**SPEC.VEH.**

Ø40x62x24    4SD24    5SD19

**SANDEN** **6SD54**



Ø 132/123mm  
 1V6  
 12V  
 PXC16

**VOLVO**

Ø35x52x20    4SD33    5SD15

**SANDEN** **6SD55**



Ø 114/110mm  
 1V6  
 12V  
 PXC16

**VOLVO**

Ø35x52x20    4SD33    5SD15

**SANDEN** **6SD56**



Ø 107/103mm  
 1V6  
 12V  
 TRS

**HONDA**

Ø35x50x20    4KE02    5SD13

**SANDEN** **6SD57** *NEW!!! v.01*



Ø 113/109mm  
 1V7  
 12V

**FORD**

Ø35x50x20    4SD12    5SD15

**SANDEN** **6SD58** *NEW!!! v.01*



Ø 123/123mm  
 1V6  
 12V  
 PXC14

**MERCEDES**

Ø35x52x20    4SD36    5SD19

**SANDEN** **6SD59** *NEW!!! v.01*



Ø 140/136mm  
 1V7  
 24V  
 SD7H15

**DAF**

Ø35x55x20    4SD24    5SD09

**SANDEN** **6SD60** *NEW!!! v.01*



Ø 124/120mm  
 1V11  
 24V  
 SD7H15

**SPEC.VEH.**

Ø35x55x20    4SD08    5SD11

**SANDEN** **6SD61** *NEW!!! v.01*



Ø 109/105mm  
 1V7  
 12V  
 HS110R/  
 TRSE07

**HONDA**

Ø35x50x20    4SD24    5SD19

**SANDEN** **6SD62** *NEW!!! v.01*



Ø 113/109mm  
 1V6  
 12V  
 TRSE09/  
 TRSA09

**HONDA**

Ø32x47x18    4SD24    5SD19

**SANDEN** **6SD64** *NEW!!! v.01*



Ø 129/125mm  
 1V7  
 12V  
 SD6V12

**RENAULT**

Ø35x55x20    4SD24    5SD19

**SEIKO-SEIKI** **6SS01**



Ø 110/110mm  
 1V5  
 12V

**BMW**

Ø30x55x23    4SS02    5SS02

**SEIKO-SEIKI** **6SS02**



Ø 110/110mm  
 1V5  
 12V

**BMW**

Ø30x55x20    4SS02    5SS02

**SEIKO-SEIKI** **6SS03**



Ø 124/120mm  
 1V4  
 12V  
 SS-96

**SMART**

Ø32x47x18    4ZX09    5SD15

**SEIKO-SEIKI** **6SS04**



Ø 114/108mm  
 1V6  
 12V

**CITROEN/PEUGEOT**

Ø32x47x18    4SS04    5SD15

**VISTEON** **6VI01**



Ø 117/108mm  
 1V5  
 12V  
 VS-16

**FORD/VOLVO**

Ø35x55x20    4VI01    5VI01



**VISTEON** **6VI02**



Ø 117/108mm  
 V6  
 12V  
 VS16

**FORD/VOLVO**

Ø35x55x20    4VI01    5VI01

**VISTEON** **6VI03**



Ø 117/108mm  
 V6  
 12V  
 VS-16

**FORD**

Ø35x55x20    4VI04    5VI03

**VISTEON** **6VI04**



Ø 131/127mm  
 V7  
 12V  
 VS16

**FORD**

Ø35x55x20    4VI02    5VI02

**VISTEON** **6VI05**



Ø 117/108mm  
 V6  
 12V  
 VS-16

**FORD**

Ø35x55x20    4VI01    5VI04

**VISTEON** **6VI06**



Ø 135/127mm  
 V6  
 12V  
 VS-16

**FORD**

Ø35x55x20    4VI05    5VI06

**VISTEON** **6VI07**



Ø 108/117mm  
 V6  
 12V

**FORD**

Ø35x55x20    4VI06    5VI07

**VISTEON** **6VI08**



Ø 110mm  
 V6  
 12V  
 VS

**BMW**

Ø35x52x20    n/a    5VI05

**VISTEON** **6VI09**



Ø 114/109mm  
 V7  
 12V  
 VS

**FORD**

Ø35x52x22    4VI01    5VI09

**VISTEON** **6VI10**



Ø 117/108mm  
 V4  
 12V  
 VS-16

**FORD**

Ø35x55x20    4VI01    5VI10

**VISTEON** **6VI11** *NEW!!! v.01*



Ø 131/127mm  
 V7  
 12V  
 VS16

**FORD**

Ø35x55x20    4VI01    5VI11

**YORK** **6YO01**



Ø 152/ mm  
 2A  
 24V  
 ER210R

**SPEC.VEH.**

Ø30x55x23    4YO20    5YO01

**YORK** **6YO02**



Ø 178/ mm  
 2A  
 12V  
 ER210R

**SPEC.VEH.**

Ø30x55x23    4YO01    5YO02

**ZEXEL** **6ZX01**



Ø 125/120mm  
 V7  
 12V  
 DCS17/  
 KC88

**MERCEDES**

Ø35x52x20    n/a    5ZX02

**ZEXEL** **6ZX02**



Ø 123/119mm  
 V6  
 12V  
 DKS15CH/  
 DKS17CH

**VOLVO**

Ø35x55x20    4ZX04    5ZX05

**ZEXEL** **6ZX03**



Ø 123/119mm  
 V4  
 12V  
 DCW17

**AUDI/VW**

Ø35x55x20    n/a    5ZX03

**ZEXEL** **6ZX04**



Ø 135/ mm  
 2A  
 24V  
 TM08/13/  
 15/16HD

**SPEC.VEH.**

Ø35x55x20    4ZX21    5ZX03

**ZEXEL** **6ZX05**



Ø 114/110mm  
 V6  
 12V  
 DCS17E

**AUDI/SEAT**

Ø35x52x20    n/a    5ZX01

**ZEXEL** **6ZX06**



Ø 115/110mm  
 V6  
 12V  
 DCS-17/  
 KC-88

**MERCEDES**

Ø35x52x20    n/a    5ZX02





**ZEXEL** **6ZX07**  

 Ø 114/110mm  
 V5  
 12V  
 DCS-17EC  
**VOLVO**  
 035x55x20 4ZX03 5ZX04

**ZEXEL** **6ZX08**  

 Ø 135/ mm  
 12A  
 12V  
 TM08/13/15/16HD  
**SPEC.VEH.**  
 035x55x20 4ZX01 5ZX03

**ZEXEL** **6ZX09**  

 Ø 123/119mm  
 V8  
 12V  
 TM08/13/15/16HD  
**SPEC.VEH.**  
 035x55x20 4ZX01 5ZX03

**ZEXEL** **6ZX10**  

 Ø 122/119mm  
 V8  
 24V  
 TM08/13/15/16HD  
**SPEC.VEH.**  
 035x55x20 4ZX21 5ZX03

**ZEXEL** **6ZX11**  

 Ø 120mm  
 V4  
 12V  
 DKV08R  
**NISSAN**  
 032x46x18 4ZX07 5ZX08

**ZEXEL** **6ZX12**  

 Ø 119/115mm  
 V7  
 12V  
 KC-88/DCS-17  
**OPEL/RENAULT**  
 035x55x20 4ZX02 5ZX07

**ZEXEL** **6ZX13**  

 Ø 119/115mm  
 V6  
 12V  
 KC-88/DCS-17EC  
**OPEL/RENAULT/NISSAN**  
 035x55x20 4ZX02 5ZX07

**ZEXEL** **6ZX14**  

 Ø 104/100mm  
 V4  
 12V  
 DKV-10R  
**SUBARU**  
 032x47x18 4ZX10 5ZX09

**ZEXEL** **6ZX15**  

 Ø 104/100mm  
 V7  
 12V  
 DKV-10R  
**SUBARU**  
 032x47x18 4ZX10 5ZX12

**ZEXEL** **6ZX16**  

 Ø 155/151mm  
 V8  
 24V  
 TM31/TM32  
**SPEC.VEH.**  
 040x68x30 4ZX24 5ZX10

**ZEXEL** **6ZX17**  

 Ø 104/100mm  
 V4  
 12V  
 DKV-08R  
**SUZUKI**  
 032x47x18 4ZX09 5ZX11

**ZEXEL** **6ZX18**  

 Ø 123mm  
 V6  
 12V  
 KC-88  
**RENAULT**  
 035x55x20 4ZX05 5ZX07

**ZEXEL** **6ZX19**  

 Ø 114/110mm  
 V5  
 12V  
 DCS-14IC  
**SUZUKI**  
 035x55x22 4ZX03

**ZEXEL** **6ZX20**  

 Ø 129/125mm  
 V6  
 12V  
 DCS-17EC  
**RENAULT**  
 032x55x20

**ZEXEL** **6ZX21**  

 Ø 139/135mm  
 V7  
 12V  
 DVE-16/DCS-17D  
**NISSAN**  
 035x55x20 5ZX03

**ZEXEL** **NEW!!! v.01** **6ZX22**  

 Ø 129/125mm  
 V6  
 12V  
 DKS-17D  
**RENAULT**  
 035x55x20 4ZX06

**ZEXEL** **NEW!!! v.01** **6ZX23**  

 Ø 113/108mm  
 V7  
 12V  
 DKV-09/DKV-10  
**NISSAN**  
 032x47x18

**ZEXEL** **NEW!!! v.01** **6ZX25**  

 Ø 125/ mm  
 1A  
 12V  
 DKS15D  
**MITSUBISHI**  
 035x55x20

**ZEXEL** *NEW!!!* **6ZX26**  
v. 01



Ø 134/130mm  
 VWV6  
 12V  
 KC-88

**VOLVO**

035x55x22    4ZX11    

**ZEXEL** *NEW!!!* **6ZX27**  
v. 01



Ø 129/119/125mm  
 VWV12X V5  
 12V  
 DKS15D

**VOLVO**

035x55x20    4ZX08    

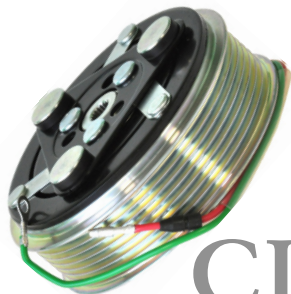

# CLUTCH ASSY BY CAR

Sprzęgła kompletne po marce Samochodów

CAR	CLUTCH
AUDI	6DL07, 6DL18, 6DN01, 6DN03, 6DN05, 6DN12, 6DN13, 6DN14, 6DN15, 6DN36, 6DN37, 6DN40, 6DN43, 6DN51, 6DN52, 6DN54, 6DN60, 6DN73, 6DN76, 6DN93, 6DN113, 6DN122, 6DN125, 6DN130, 6SD01, 6SD02, 6SD03, 6SD10, 6ZX03, 6ZX05
BMW	6CL01, 6CL05, 6CL10, 6CL11, 6CL12, 6CL15, 6DN11, 6DN27, 6DN29, 6DN29, 6DN48, 6DN58, 6DN62, 6DN63, 6DN64, 6DN65, 6DN121, 6DN131, 6SS01, 6SS02, 6VI08
CHEVROLET	6DL10, 6DL11, 6DL12, 6DL16, 6DL19
CHRYSLER	6DN41, 6DN47, 6DN88, 6DN91, 6DN94, 6DN111, 6DN114
CITROEN	6DN28, 6DN92, 6DN136, 6DN139, 6SD07, 6SD12, 6SD30, 6SD38, 6SD39, 6SS04
DACIA	6ZX24
DAF	6SD59
FIAT	6DN19, 6DN25, 6DN39, 6DN49, 6DN53, 6DN71, 6DN79, 6DN120, 6DN132, 6SD39
FORD	6FS01, 6FS02, 6HA15, 6HA19, 6SC01, 6SD06, 6SD35, 6SD39, 6SD44, 6SD57, 6VI01, 6VI02, 6VI03, 6VI04, 6VI05, 6VI06, 6VI07, 6VI09, 6VI10, 6VI11
HONDA	6DN23, 6DN72, 6DN108, 6DN135, 6KE01, 6KE02, 6KE03, 6KE04, 6SD13, 6SD16, 6SD17, 6SD22, 6SD23, 6SD24, 6SD33, 6SD56, 6SD61, 6SD62
HYUNDAI	6HA01, 6HA02, 6HA03, 6HA04, 6HA05, 6HA09, 6HA10, 6HA12, 6HA13, 6HA14, 6HA16, 6HA17, 6HA18, 6HA20, 6HA21
ISUZU	6DN57
IVECO	6DN22, 6DN82, 6DN83
KIA	6DN134, 6HA01, 6HA03, 6HA04, 6HA05, 6HA06, 6HA07, 6HA08, 6HA11, 6HA12, 6HA13, 6HA14, 6HA16, 6HA17, 6HA20, 6HA21
LAND ROVER	6DN137
LEXUS	6DN50, 6DN67, 6DN107
MAZDA	6PA01, 6PA02, 6PA03, 6PA04, 6PA05, 6PA06, 6PA07, 6PA08, 6PA11, 6SD06
MERCEDES	6DN04, 6DN05, 6DN06, 6DN10, 6DN16, 6DN18, 6DN20, 6DN26, 6DN30, 6DN36, 6DN38, 6DN40, 6DN42, 6DN44, 6DN45, 6DN46, 6DN55, 6DN56, 6DN61, 6DN74, 6DN77, 6DN80, 6DN81, 6DN84, 6DN85, 6DN86, 6DN89, 6DN110, 6DN114, 6DN123, 6DN127, 6DN129, 6DN130, 6DN138, 6SD58, 6ZX01, 6ZX06
MITSUBISHI	6DN90, 6DN118, 6DN133, 6MI01, 6MI02, 6MI03, 6MI04, 6MI05, 6MI07, 6ZX25
NISSAN	6CL02, 6CL03, 6CL04, 6CL06, 6CL07, 6CL09, 6CL13, 6CL14, 6DL02, 6DL08, 6ZX11, 6ZX13, 6ZX21, 6ZX23, 6ZX24
OPEL	6DL01, 6DL03, 6DL04, 6DL05, 6DL06, 6DL09, 6DL13, 6DL15, 6DL16, 6DL19, 6DL20, 6DL20, 6DN19, 6DN25, 6DN33, 6DN120, 6SD09, 6SD14, 6SD21, 6SD40, 6SD43, 6ZX12, 6ZX13
PEUGEOT	6DN92, 6DN136, 6DN139, 6SD07, 6SD12, 6SD30, 6SD38, 6SD39, 6SS04
PORSCHE	6DN51, 6DN122
RENAULT	6CL08, 6DL02, 6DL08, 6DL14, 6DL17, 6DL22, 6DN28, 6DN126, 6SD15, 6ZX12, 6ZX13, 6ZX18, 6ZX20, 6ZX22, 6ZX24
SAAB	6SD05, 6SD14, 6SD21
SEAT	6DL07, 6DL18, 6DN03, 6DN37, 6DN54, 6SD01, 6SD02, 6SD03, 6SD10, 6SD35, 6SD45, 6SD52, 6ZX05
SKODA	6DL07, 6DL18, 6DN03, 6DN37, 6DN54, 6SD01, 6SD02, 6SD03, 6SD10, 6ZX0
SMART	6SS03
SPECIAL VEHICLES	6DL21, 6DN66, 6DN70, 6DN75, 6DN95, 6DN96, 6DN97, 6DN98, 6DN99, 6DN100, 6DN101, 6DN102, 6DN103, 6DN104, 6DN105, 6DN106, 6SD08, 6SD11, 6SD18, 6SD19, 6SD20, 6SD26, 6SD27, 6SD28, 6SD31, 6SD32, 6SD34, 6SD36, 6SD41, 6SD42, 6SD45, 6SD47, 6SD48, 6SD49, 6SD50, 6SD51, 6SD53, 6SD60, 6YO01, 6YO02, 6ZX04, 6ZX08, 6ZX09, 6ZX10, 6ZX16
SUBARU	6DN132, 6ZX14, 6ZX15
SUZUKI	6DN59, 6DN120, 6MI06, 6PA09, 6PA10, 6ZX17, 6ZX19
TOYOTA	6DN07, 6DN08, 6DN09, 6DN17, 6DN21, 6DN24, 6DN31, 6DN34, 6DN35, 6DN39, 6DN49, 6DN50, 6DN53, 6DN67, 6DN68, 6DN69, 6DN71, 6DN78, 6DN79, 6DN89, 6DN107, 6DN109, 6DN112, 6DN115, 6DN117, 6DN128, 6DN132
VOLVO	6SD25, 6SD44, 6SD54, 6SD55, 6VI01, 6VI02, 6ZX02, 6ZX07, 6ZX26, 6ZX27
VW	6DL07, 6DL18, 6DN02, 6DN03, 6DN15, 6DN32, 6DN37, 6DN43, 6DN51, 6DN52, 6DN54, 6DN73, 6DN76, 6DN87, 6DN93, 6DN119, 6SD01, 6SD02, 6SD04, 6SD10, 6SD35, 6SD37, 6SD45, 6SD52, 6SD54, 6SD55, 6ZX03, 6ZX05





7XX01

1-pin

VOLKSWAGEN



7XX02

1-pin

mitsubishi



7XX03

2-pin

VOLKSWAGEN



7XX04

2-pin

VOLKSWAGEN

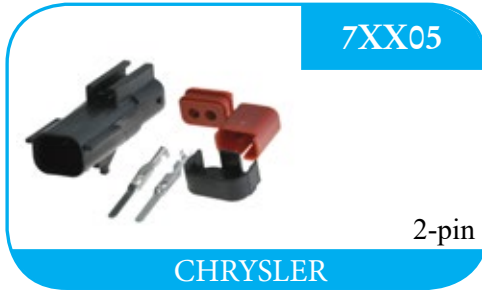

7XX05

2-pin

CHRYSLER



7XX06

2-pin

OPEL

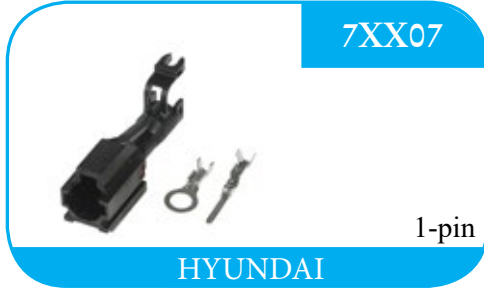

7XX07

1-pin

HYUNDAI



7XX08

1-pin

NISSAN



7XX09

1-pin

KIA



7XX10

2-pin

PEUGEOT



7XX11

1-pin

HONDA



7XX12

2-pin

FORD



7XX13

1-pin

BMW/MERCEDES



7XX14

1-pin

HYUNDAI



7XX15

2-pin

FORD



7XX16

2-pin

RENAULT

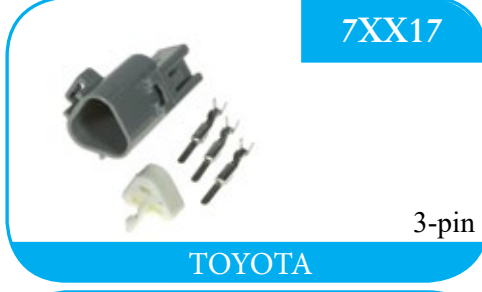

7XX17

3-pin

TOYOTA



7XX18

2-pin

VOLKSWAGEN



7XX19

1-pin

MERCEDES



7XX20

2-pin

BMW



7XX21

2-pin

BMW



**8XX01**



HAND CRIMPERS

**8XX02**



CABLES SERVICE WITH PRESSURE GAUGE

**8XX03**



COMPRESSOR CLUTCH TOOL SET

**8XX04**



TESTER CONTROL VALVES

**8XX05**



CABLES FOR TESTER 8XX04

**8XX06**



UV LED FLASH LIGHT

**8XX07**



COMPRESSOR CLUTCH TOOL SET

**8XX08**



AUTOMATIC HALOGEN LEAK DETECTOR KIT

**8XX09**



WEIGHT

**8XX10**



1L PAG 100

**8XX11**



COMPRESSOR CLUTCH TOOL SET

**8XX14**



O-rings PICK SET (1 SET)

**8XX15**



1L PAG 46

**8XX16**



SHAFT SEAL TOOL KITS

**NEW!!! v. 01 8XX21**



SPRINGLOCK #6 (3/8") (1 Set/20pcs)

**NEW!!! v. 01 8XX22**



SPRINGLOCK #8 (1/2") (1 Set/20pcs)

**NEW!!! v. 01 8XX23**



SPRINGLOCK #10 (5/8") (1 Set/20pcs)

**NEW!!! v. 01 8XX24**



SPRINGLOCK #12 (3/4") (1 Set/20pcs)

**NEW!!! v. 01 8XX25**



SHAFT SEAL TOOL KITS

**8XX100**



O-rings

**8XX101**



O-rings





**8XX102**

O-rings



**8XX103**

O-rings



**8XX104**

GM SLIM-LINE  
WASHER KIT



**8XX105**

VALVE COR  
ASSORTMENT  
KIT  
(8 DIFFERENT  
CORES)



**8XX106**

FORD, SEAT,  
SKODA, VW  
VALVE R134A  
LOW SIDE  
PRIMARY  
SEAL



**8XX107**

R134A RETRO  
FITTING 7/16  
LOW SIDE  
STEEL  
(1 Set/5pcs)



**8XX108**

FORD, SEAT,  
SKODA, VW  
VALVE R134A  
HIGH SIDE  
PRIMARY  
SEAL



**8XX109**

R134A  
RETRO  
FITTING  
7/16 HIGH SIDE  
STEEL  
(1 Set/5pcs)



**8XX110**

OPEL O-rings



**8XX111**

MANUAL LOW  
SIDE COUPLER  
FOR R1234YF



**8XX112**

MANUAL  
HIGH SIDE  
COUPLER FOR  
R1234YF



**8XX113**

R134A VALVE  
CORE  
VOLVO/  
PEUGEOT  
(1 Set/5pcs)



**8XX114**

VALVE CORE  
GM/FORD JRA  
IMPORT  
(1 Set/5pcs)

**9XX02**



3-pin  
OPEL:  
6850512/9131721  
RENAULT:  
7700417506/  
7701205751

OPEL/RENAULT

**9XX03**



3-pin  
VW:  
1J0959126/  
8Z0959126

VW

**9XX04**



3-pin  
CITROEN/  
PEUGEOT:  
6455.Z3  
FIAT:  
9647971280

CITROEN/PEUGEOT/FIAT

**9XX05**



4-pin  
VW:  
1H0959139A/  
1H0959139B

VW

**9XX06**



3-pin  
VOLVO:  
31292004

VOLVO

**9XX07**



3-pin  
RENAULT:  
921361722R

RENAULT

**9XX08**



3-pin  
MERCEDES:  
2110000283

MERCEDES

**9XX09**



3-pin  
MERCEDES:  
6395420818/  
1408300072

MERCEDES

**9XX10**



2-pin  
HONDA:  
MT0358

HONDA

**9XX11**



3-pin  
JEEP:  
5072138AA

JEEP

**9XX12**



4-pin  
FORD:  
8L8Z19D594A/  
XS4Z19D594AA

FORD

**9XX13**



3-pin  
FORD:  
6F9319D594AA/  
6F9319D594AA

FORD

**9XX14**



3-pin  
BMW:  
64536909257

BMW

**9XX15**



3-pin  
NISSAN:  
92136-6J010

NISSAN

**9XX16**



4-pin  
TOYOTA:  
499000-7141

TOYOTA

**9XX17**



4-pin  
OPEL:  
1854780/  
90506752

OPEL

**9XX18**



3-pin  
VOLVO:  
30899051

VOLVO

**9XX19**



5-pin  
FIAT:  
46476438

FIAT

**9XX20**



4-pin  
OPEL:  
1854779/  
90506751

OPEL

**9XX21**



4-pin

UNIVERSAL

**9XX22**



4-pin

UNIVERSAL



**9XX23**

4-pin  
NISSAN:  
92137-4S100

NISSAN



**9XX24**

2-pin

FORD



**9XX25**

3-pin  
VW:  
3R0 959 126

VW



**9XX26**

3-pin  
HONDA:  
80450S7S003/  
80450SFE003

HONDA



**9XX28**

2-pin

UNIVERSAL



**9XX29**

3-pin

VW



**9XX30**

3-pin

CHRYSLER/JEEP



**9XX31**

2-pin

BMW



**9XX32**

4-pin

HONDA



**9XX33**

4-pin  
VW:  
3D0959126B

VW



**9XX34**

2-pin  
CHRYSLER:  
4773101/  
4798599

CHRYSLER



**9XX35**

3-pin  
FORD:  
BT4318D584AA

FORD



**9XX36**

3-pin

CHRYSLER/DODGE



**9XX37**

2-pin

JEEP



**9XX38**

5-pin

ALFA ROMEO/FIAT/LANCIA



**9XX39**

4-pin  
FORD:  
F2CZ-19D594-A

FORD



**9XX40**

2-pin  
CHEVROLET/  
ISUZU/SAAB:  
15144494

CHEVROLET/ISUZU/SAAB



**9XX41**

2-pin  
CHRYSLER/  
DODGE:  
5290240AB

CHRYSLER/DODGE



**9XX42**

4-pin  
LAND ROVER:  
CDP5560/  
JTB100220

LAND ROVER



**9XX43**

3-pin

MITSUBISHI



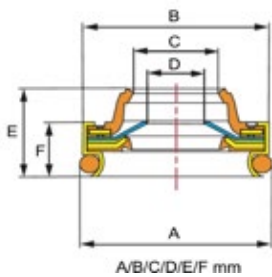

SANDEN/  
DELPHI/ ZEXEL

10XX01



A: - B: 26,3  
C: 13 D: 10,5  
E: 11,25 F: 7,1

DENSO

10XX02



A: - B: 27,23  
C: 13,27 D: 9,7  
E: 12,05 F: 9,53

DELPHI

10XX03



A: - B: 31,6  
C: 10,8 D: -  
E: 7,7 F: -

SANDEN

10XX04



A: 27 B: 25,83  
C: 13,87 D: 9,37  
E: 11,42 F: -

10XX05



A: - B: 23,48  
C: 12,66 D: 10,05  
E: 10,3 F: 7  
 FX15/FS10

PANASONIC

10XX06



A: 24 B: 22,84  
C: 10,29 D: -  
E: 10,29 F: -

DENSO

10XX07



A: - B: 30,35  
C: 30,35 D: 11,09  
E: 15,18 F: 10

DIESEL KIKI

10XX08



A: - B: 30,42  
C: 13,75 D: 11,4  
E: 14,9 F: 9,8

DELPHI

10XX09



A: 26,09 B: 25  
C: 13,45 D: 9,28  
E: 11,2 F: 7,8  
 V5

DENSO

10XX10



A: - B: 26,48  
C: 13,48 D: 10,1  
E: 14,2 F: 9,73

SCROLL

10XX11



A: - B: 24,32  
C: 12,07 D: 8,1  
E: 11,25 F: 7,13

10XX12



A: - B: 24,38  
C: 12,28 D: 9,39  
E: 10,16 F: 6,92

DENSO

10XX13



A: 30,65 B: 29,9  
C: 29,9 D: 11,22  
E: 14,7 F: 8,81

10XX14



A: 23,62 B: 22,87  
C: - D: 8,46  
E: 14,53 F: -

DELPHI

10XX15



A: - B: 31,34  
C: 11,28 D: 10,44  
E: 9,8 F: -

DIESEL KIKI

10XX16



A: 30,59 B: 30  
C: 10,95 D: 9,8  
E: 14,14 F: -  
 DKS16H

10XX17



A: - B: 24,12  
C: 11,7 D: 9,12  
E: 12,39 F: 7,86

10XX18



A: - B: 26,25  
C: 13,29 D: 10,43  
E: 12 F: 7

10XX19



A: - B: 30,04  
C: 15 D: 10,12  
E: 11,15 F: 6

DIESEL KIKI

10XX20



A: 33,09 B: 31,88  
C: 17,45 D: 11,14  
E: 14,82 F: -  
 DKS32C

<p><b>SANDEN</b> <b>10XX21</b></p>  <p>A: 25,1 B: 24 C: 13,3 D: 10,3 E: 11,88 F: -</p>	<p><b>SANDEN</b> <b>10XX22</b></p>  <p>A: - B: 25 C: 12,4 D: 10,4 E: 11,3 F: 7</p> <p> PXC14</p>	<p><b>10XX23</b></p>  <p>A: 40,6 B: 39,9 C: 19,6 D: 15,1 E: 12,2 F: -</p> <p> TM31</p>
<p><b>10XX24</b></p>  <p>A: - B: 24,4 C: 11,4 D: 9,6 E: 10,9 F: 7</p>	<p><b>DENSO</b> <b>10XX25</b></p>  <p>A: - B: 24,7 C: 12,6 D: 10,5 E: 11,1 F: 7</p>	<p><b>CALSONIC</b> <b>10XK01</b></p>  <p>A: 31,5 B: - C: 15 D: 9,5 E: 10 F: 7,3</p>
<p><b>10XK02</b></p>  <p>A: - B: 31,7 C: 13,31 D: 10 E: 8,64 F: -</p>	<p><b>CALSONIC</b> <b>10XK03</b></p>  <p>A: - B: 31,6 C: 10,8 D: - E: 7,7 F: -</p>	<p><b>10XK04</b></p>  <p>A: - B: 29,21 C: 15,61 D: - E: 11,58 F: 8,18</p>
<p><b>10XK05</b></p>  <p>A: - B: 23,48 C: 12,66 D: 10,05 E: 10,05 F: 7</p>	<p><b>DENSO</b> <b>10XK06</b></p>  <p>A: 29,1 B: 26,8 C: 16,2 D: - E: 23,5 F: 15</p>	<p><b>DENSO</b> <b>10XK07</b></p>  <p>A: - B: 30,35 C: 13,42 D: 11,09 E: 11,09 F: 10</p>
<p><b>SANDEN</b> <b>10XK08</b></p>  <p>A: 25 B: 22 C: - D: 12 E: 23 F: 15</p>	<p><b>Matshita/ Panasonic</b> <b>10XK09</b></p>  <p>A: 23 B: 22 C: - D: 12 E: 23 F: 15</p>	<p><b>SANDEN</b> <b>10XK10</b></p>  <p>A: - B: 24,3 C: 11,83 D: 9,08 E: 10,3 F: 7,05</p>
<p><b>VISTEON</b> <b>10XK11</b></p>  <p>A: 24,55 B: 24 C: 12,87 D: 9,54 E: 12,05 F: -</p>	<p><b>DELPHI/ HARRISON</b> <b>10XK12</b></p>  <p>A: 31,8 B: 28 C: 15 D: - E: 25 F: 17,5</p>	<p><b>10XK13</b></p>  <p>A: 27 B: 25,83 C: 13,87 D: 9,37 E: 9,37 F: 11,42</p>
<p><b>DENSO</b> <b>10XK14</b></p>  <p>A: - B: 30,35 C: 13,42 D: 11,09 E: 15,18 F: 10</p>	<p><b>YORK</b> <b>10XK15</b></p>  <p>A: 38 B: - C: 21,7 D: - E: 13,4 F: -</p>	<p><b>YORK</b> <b>10XK16</b></p>  <p>A: 76,7 B: 39,4 C: 21,5 D: - E: 18,5 F: -</p>

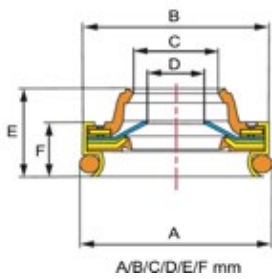

**DELPHI/HARRISON** **10XK17**

A: 12,9 B: 10,7  
C: 12,9 D: 10,7  
E: 13 F: 9,7

**SEIKO-SEIKI** **10XK18**

A: 29,2 B: 27,5  
C: 13,8 D: -  
E: 25,6 F: 17,3

**10XK19**

A: 27,8 B: -  
C: 12,7 D: 9,4  
E: 10,7 F: 6,2

**HITACHI**

**DENSO** **NEW 10XK20**

A: 30,5 B: 29,5  
C: 15,5 D: 12  
E: 11,5 F: -

**TV12C**

**NEW 10XK21**

A: 31 B: 28  
C: 13,5 D: -  
E: 27 F: 17

**NEW 10XK22**

A: - B: 30,5  
C: 13,5 D: 11  
E: 14,5 F: 10

**ZEXEL** **NEW 10XK23**

A: - B: 30  
C: 18,5 D: -  
E: 8 F: -

**BERG WINGCELL/NIHON DKV14B**

**YORK** **NEW 10XK24**

A: 32 B: 28  
C: 13 D: -  
E: 27 F: 17

**SANDEN** **NEW 10XK25**

A: 27,5 B: 24,7  
C: 14 D: -  
E: 22,5 F: 14,8

**SD708**

**DELPHI** **10XX101**

**V5**

**DELPHI** **10XX102**

**CVC**

**10XX103**

**10PA**

**FORD** **10XX104**

**FX**

**HALLA** **10XX105**

**SANDEN** **10XX106**

**DENSO** **10XX107**

**7SB16C**

**DENSO** **10XX109**

**10PA17C**

**SANDEN** **10XX110**















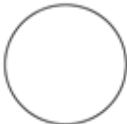



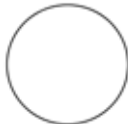









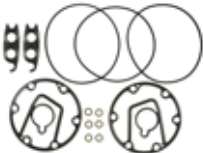

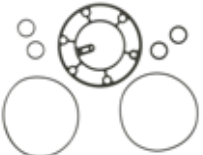

**SD7V16**

**MITSUBISHI** **10XX111**

**MSC90C**

**SCROLL** **10XX112**



<p>CALSONIC/ DIESEL KIKI</p> <p>10XX114</p> 	<p>SANDEN</p> <p>10XX115</p>   SD6V12	<p>DENSO</p> <p>10XX118</p>   10P13/10P15
<p>DELPHI</p> <p>10XX119</p>   SP10	<p>SANDEN</p> <p>10XX120</p>   PXE16 G25-3102	<p>SEIKO-SEIKI</p> <p>10XX121</p>  <p>M35-1003</p>
<p>DIESEL KIKI</p> <p>10XX122</p>  <p>M20-2159</p>	<p>PANASONIC</p> <p>10XX123</p>  <p>MT0341</p>	<p>10XX124</p>   10P08E
<p>VISTEON/KEIHIN/ GM/ HARRISON</p> <p>10XX125</p> 	<p>DENSO</p> <p>NEW! 10XX126</p>   10P17C	<p>DENSO</p> <p>10XX200</p>   10S G20-2010
<p>DENSO</p> <p>10XX201</p>   CHRYSLER C171 MT2109	<p>SANDEN</p> <p>10XX203</p>   CHRYSLER SD6C17 K11-2115	<p>FORD FS</p> <p>10XX204</p>  <p>K12-2125</p>
<p>DELPHI</p> <p>10XX205</p>   V5 K13-2020	<p>DELPHI</p> <p>10XX206</p>   V5 K13-2120	<p>DELPHI</p> <p>10XX207</p>   V5 K13-2121
<p>DELPHI</p> <p>10XX208</p>  <p>K13-2128</p>	<p>DENSO</p> <p>10XX209</p>  <p>K20-2158</p>	<p>DENSO</p> <p>10XX210</p>   10PA17C K20-2159

**DENSO** **10XK211**



 10S  
K20-2161

**DENSO** **10XK212**

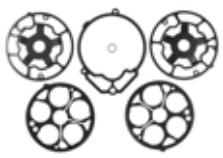

 10S13  
K20-2170

**SANDEN** **10XK213**



 SD708/SD709/SD7H15  
K25-2115

**SANDEN** **10XK214**



 SD7V16  
K25-2127

**SANDEN** **10XK215**



 SD6V12  
K25-2140

**DELPHI** **10XK216**

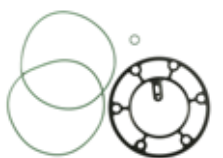

 V5  
K75-2100

**DENSO** **10XK217**



 7SB16  
MT2195

**SANDEN** **10XK218**



 PXE16  
MT2210

**SANDEN** **10XK219**



 PXE13  
MT2223

**DENSO** **10XK220**



 5SE09C  
MT2242

**DENSO** **10XK221**



 5SE12C  
MT2243

**VISTEON** **10XK222**



 VS16  
MT2247

**DENSO** **10XK223**



 6SEU12  
MT2360

**DENSO** **10XK224**



 6SEU16  
MT2361

**DIESEL KIKI** **10XK225**



 DCW17  
MT2372

**DENSO** **10XK226**



 7SBU16/7SEU16  
MT2359

**DELPHI/HARRISON** **10XK227**

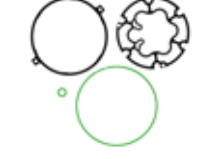

 MT2226

**DENSO** **10XK228**



 10PA17C  
MT2305

**DELPHI/HARRISON** **10XK229**

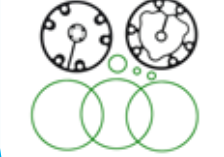

 MT2198

**DENSO** **10XK230**

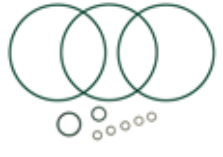

 10P17C  
MT2134

**DENSO** **10XK231**



 10P17C  
MT2305

**DELPHI/GM/  
HARRISON** **10XK232**



 A6  
MT2117

**ZEXEL** **10XK233**



 TM13 / TM15  
MT2370

**DIESEL KIKI** **10XK234**



 DKS17CH  
MT2269

**MATSUSHITA/  
PANASONIC** **10XK235**



MT2275

**VISTEON** **10XK236**



 HS090  
MT2358

**DELPHI/  
HARRISON** **10XK237**

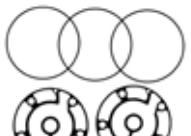

 SP10  
MT2189

**YORK** **10XK238**



 206, 209, 210  
MT2080

**CHRYSLER** **10XK239**



 RV2  
MT2110

**DENSO** **10XK240**



 TV12SC /TV14SC  
MT2142

**SANDEN** **10XK241**



 SD7V16  
MT2218

**DENSO** **10XK242**



 10PA20  
MT2308

**SEIKO SEIKI** **10XK243**



 SS121DV2  
MT2327

**DENSO** **10XK244**



 10S15/17/10S  
MT2361

**MITSUBISHI** **10XK245**

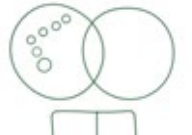

 MSC90  
MT2128

**SANDEN** **10XK246**



 SD708 / SD709 /  
SD7H15  
MT2144

**SANDEN** **10XK247**

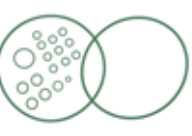

 TRSA09/TRSE07  
MT2278

**DIESEL KIKI** **10XK248**



 DCS17C/DCS17D  
MT2225

**CALSONIC** **10XK249**



 DKV14D  
MT2204

**SCROLL** **10XK250**



MT2356

**SEIKO-SEIKI** **10XK251**



 SEIKO-SEIKI  
MT2212

**BOCK** **10XK252**



 BEHG WINGCELL  
MT2107



DENSO **NEW FOR 10XK253**





10P13C / 10P15C



MT2133

YORK **NEW FOR 10XK254**



MT2184

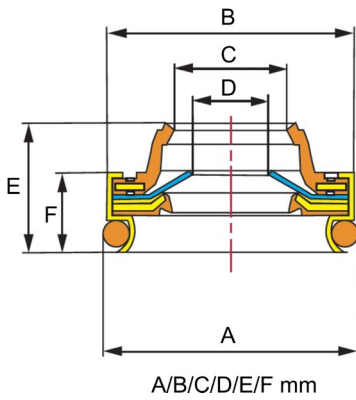

# SEALS (shaft)

Uszczelnienia czołowe



Nr AcAuto	A	B	C	D	E	F	Application
10XK17	12,9	10,7	12,9	10,7	13	9,7	HARRISON
10XX06	24	22,84	10,29	-	10,29	-	MATSUSHITA/PANASONIC - N1301/NL1300
10XX14	23,62	22,87	-	8,46	14,53	-	
10XK05	-	23,48	12,66	10,05	10,05	7	FORD - FS10/FX15
10XX05	-	23,48	12,66	10,05	10,3	7	FORD - FS10/FX15
10XK11	24,55	24	12,87	9,54	12,05	-	mitsubishi - AX105VSR/FX105V/FX80/FXA105VS/FXA105VSLR/FXA105VSR/ FXA105VSS/MS105CVS/MS90/MS90C / SANDEN—TR090/TR105/ TR105VS/TR70/TRF090/TRF105/TRS090
10XX21	25,1	24	13,3	10,3	11,88	-	
10XK08	25	22	-	12	23	15	SANDEN - SD505/TR70/TR90/TR105
10XK09	23	22	-	12	23	15	MATUSHITA/PANASONIC - N1300 Series, N1301 Series, NL1300, Series, S1150 Series, SA1150AE4
10XX17	-	24,12	11,7	9,12	12,39	7,86	SD505/TR70/TR90/TR105
10XK10	-	24,3	11,83	9,08	10,3	7,05	mitsubishi - AX105VSR/FX105V/FX80/FXA105VS/FXA105VSLR/FXA105VSR /FXA105VSS/MS105CVS/MS90/MS90C
10XX11	-	24,32	12,07	8,1	11,25	7,13	FORD SCROLL
10XX12	-	24,38	12,28	9,39	10,16	6,92	
10XX24	-	24,4	11,4	9,6	10,9	7	
10XX25	-	24,7	12,6	10,5	11,1	7	
10XK25	27,5	24,7	14	-	22,5	14,8	SANDEN SD708 / SD709
10XX09	26,09	25	13,45	9,28	11,2	7,8	DELPHI -V5/V7
10XX22	-	25	12,4	10,4	11,3	7	PXE14
10XK13	27	25,83	13,87	9,37	9,37	11,42	SANDEN—SD507 / SD508 / SD510 / TR80
10XX04	27	25,83	13,87	9,37	11,42	-	DENSO - 6CA17C/7SB16 / DIESEL KIKI - DKS13CH,15,17 / GM/ HARRISON - SP10 SANDEN - SD5H13/SD6V12/SD708/SD709/SD7B10/SD7H13/ SD7H15/SD7V16 SEIKO-SEIKI -SS121DV2 / TAMA—TM08/TM13
10XX18	-	26,25	13,29	10,43	12	7	
10XX01	-	26,3	13	10,5	11,25	7,1	CALSONIC - CR14 / DAEWOO - V5 / DELPHI - CVC165/CVC185 / DENSO - SC06/SCS06 DIESEL KIKI - DCW17 / SANDEN - SD5H13/SD7H15/ SD7V16/SD7C16/TRSE07/PXE13/PXE16 / SEIKO SEIKI—SS10 / TAMA - TM- 08HD/TM13/TM15/TM16
10XX10	-	26,48	13,48	10,1	14,2	9,73	DENSO -10S11/13/15/17
10XK06	29,1	26,8	16,2	-	23,5	15	CHRYSLER -A590/C171 / DENSO -10P08/10P13/10P15/10P17C/10PA15/10PA17/ 10PA15C 10PA17C/6E171/6P127/6P134/6P148 / FORD - FS6
10XX02	-	27,23	13,27	9,7	12,05	9,53	DENSO - 6SEU12/6SEU16/7SE16/7SEU16 / CALSONIC - CWV
10XK18	29,2	27,5	13,8	-	25,6	17,3	SEIKO-SEIKI
10XK12	31,8	28	15	-	25	17,5	HARRISON A6/R4
10XK21	31	28	13,5	-	27	17	HARRISON A6/R4
10XK24	32	28	13	-	27	17	YORK / TCCI
10XK04	-	29,21	15,61	-	11,58	8,18	
10XK20	30,5	29,5	15,5	12	11,5	-	DENSO- TV12C/TV12SC/TV14SC
10XX13	30,65	29,9	29,9	11,22	14,7	8,81	DENSO -10PA15/10PA17
10XX16	30,59	30	10,95	9,8	14,14	-	
10XK23	-	30	18,5	-	8	-	BEHR - WINGCELL
							NIHON DKV14B
10XK19	27,8	-	12,7	9,4	10,7	6,2	HITACHI
10XX19	-	30,04	15	10,12	11,15	6	
10XK07	-	30,35	13,42	11,09	11,09	10	DENSO-10PA15/10PA17/10PA20
10XK14	-	30,35	13,42	11,09	15,18	10	DENSO-10PA15/10PA17/10PA20
10XX07	-	30,35	30,35	11,09	15,18	10	DENSO -10PA15/10PA17/10PA20
10XX08	-	30,42	13,75	11,4	14,9	9,8	DIESEL KIKI -DKV116/DKV14C/DRV14D/DKV14G
10XK22	-	30,5	13,5	11	14,5	10	DENSO 10PA17J
10XX15	-	31,34	11,28	10,44	9,8	-	
10XX03	-	31,6	10,8	-	7,7	-	CALSONIC - V5-15 / GM/HARRISON - DA6/HR6/HR6HE/HD6/HT6/R4/V5
10XK03	-	31,6	10,8	-	7,7	-	Calsonic V5 GM/Harrison V5, R4, LTR4, DA6, HD6, HR6, HR6HE, HT6 H-Series
10XK02	-	31,7	13,31	10	8,64	-	
10XX20	33,09	31,88	17,45	11,14	14,82	-	
10XK16	76,7	39,4	21,5	-	18,5	-	YORK
10XX23	40,6	39,9	19,6	15,1	12,2	-	TM31
10XK15	38	-	21,7	-	13,4	-	
10XK01	31,5	-	15	9,5	10	7,3	DELPHI V5

SANDEN

11SD01



7/8" - 3/4"  
JD TYPE  
SD7H15

SANDEN

11SD02



7/8" - 3/4"  
KC TYPE  
SD7H15

SANDEN

11SD03



7/8" - 3/4"  
SD TYPE  
SD7H15

SANDEN

11SD04



1" - 1"  
MD TYPE  
SD7H15

SANDEN

11SD05



1" - 1"  
CB TYPE  
SD7H15

SANDEN

11SD06



17,6mm 14,5mm  
WV TYPE  
SD7H15

NEW !!!  
v.01

ZEXEL

11ZX01



7/8" - 3/4"  
COMPRESSOR  
FITTING  
HORIZONTAL  
TM

ZEXEL

11ZX02



7/8" - 3/4"  
COMPRESSOR  
FITTING  
VERTICAL  
TM





# BENDIKS.PL

ALTERNATORS & STARTERS

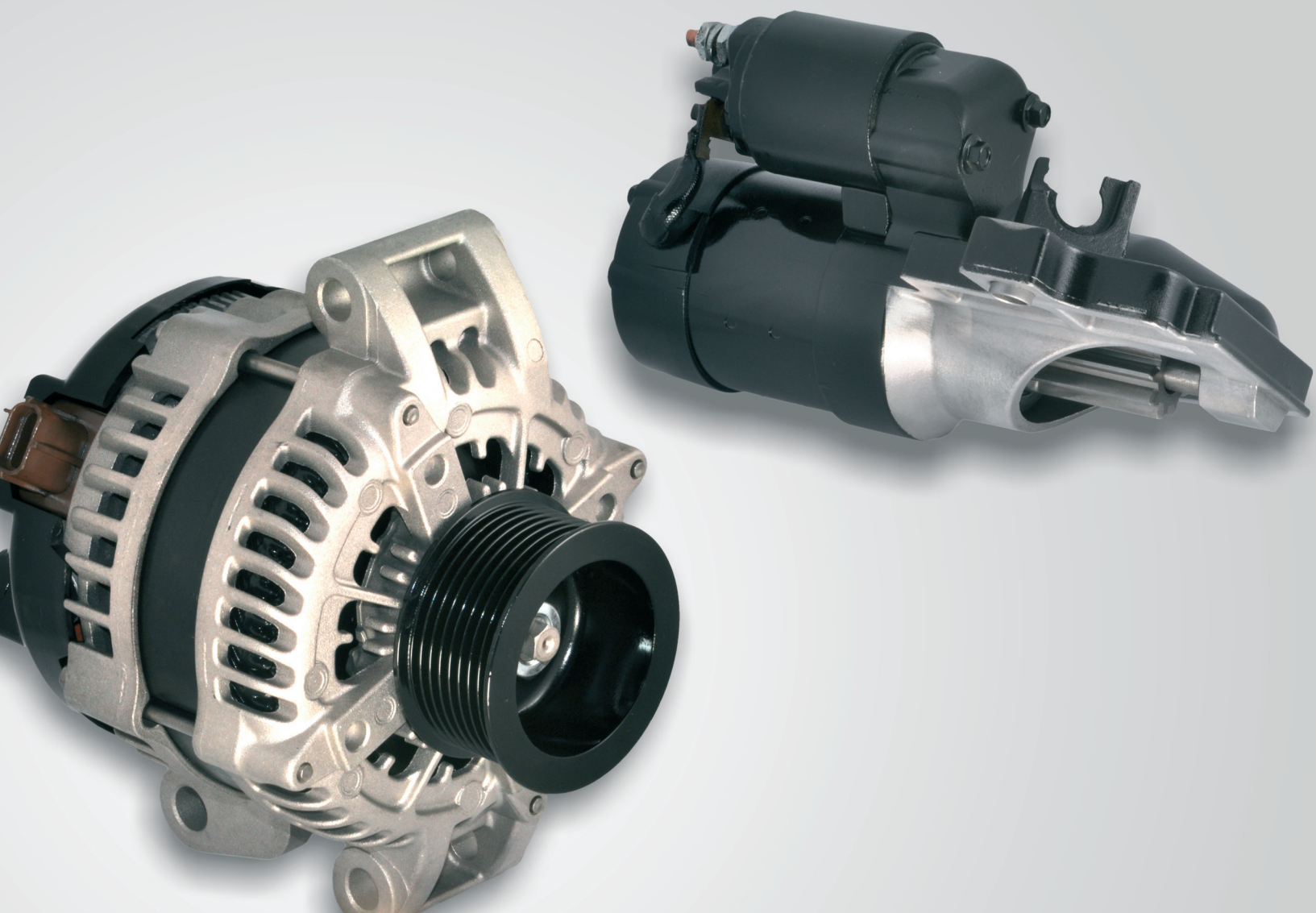

**ALTERNATORS**

**STARTERS**

**Spare parts for alternators & starters**

Części zamienne do alternatorów i rozruszników

**Remanufacturing alternators & starters**

Regeneracja alternatora i rozrusznika



**BENDIKS.PL**  
ALTERNATORS & STARTERS

05-092 Łomianki, ul. Kolejowa 117a  
tel.+ 48 22 768 72 00 mail: bendiks@bendiks.pl  
www.bendiks.pl



# A/C COMPRESSOR

**ACAUTO**

Ul. Kolejowa 117 05-092 Łomianki, Poland  
tel. +48 22 751 33 54, +48 795 335 900, +48 22 873 83 03  
email: [info@acauto.pl](mailto:info@acauto.pl) [www.acauto.pl](http://www.acauto.pl)