



AC COMPRESSOR

2020 vol.1

SPARE PARTS FOR THE COMPRESSORS

Części zamienne
do sprężarek klimatyzacji

NEW AND REBUILD COMPRESSORS

Nowe i regenerowane
kompresory

PROFESSIONAL REMANUFACTURING

Profesjonalna regeneracja

www.acauto.pl 











PROFESSIONAL REMANUFACTURING

Table of contents / Spis treści:

Control Valves / Zawory sterujące	2
Bearings / Łożyska	6
Clutch coils 12V / Elektromagnesy 12V	7
Clutch coils 24V / Elektromagnesy 24V	16
Clutch coils (technical informations) / Elektromagnesy (techniczne informacje).....	17
Clutch hubs / Tarcze sprzęgieł	20
Clutch hubs (technical informations) / Tarcze sprzęgieł (techniczne informacje)	30
Clutch assemblies / Sprzęgła kompletne	33
Clutch assemblies (technical informations) / Sprzęgła kompletne (techniczne informacje) ...	58
Plugs / Wtyczki	60
AC Service and parts / Obsługa klimatyzacji.....	62
Pressure switches / Czujniki ciśnienia	65
Shaft Seals / Uszczelnienia Czołowe	68
Gasket Seals / Uszczelnienia Boczne	71
Shaft Seals (technical informations)/ Uszczelnienia Czołowe (techniczne informacje)	75
Compressor brackets / Obudowy kompresorów	76
parts of the car installation / Części instalacji samochodowej	77

Symbols / Symbole:

-  Compressor type / Symbol kompresora
-  Diameter / Średnica
-  Number of grooves / Ilość rowków koła
- H: Fixing point clock of pin on coil / Godzina ustalająca bolec mocujący na elektromagnesie
-  Bearing / Łożysko
-  Clutch coil / Elektromagnes sprzęgła
-  Clutch hub / Tarcza sprzęgła
-  Clutch coil voltage / Woltaż elektromagnesu
-  Length of control valve / Długość zaworu sterującego

CALSONIC **2CL01**



93 mm
CWE618

NISSAN

CALSONIC **2CL02**



69 mm
V6

BMW

CALSONIC **2CL03**



96 mm

BMW E90

DELPHI **2DL01**



86 mm
V5

RENAULT

DELPHI **2DL02.G**



68 mm
V5

DELPHI **2DL02.R**



69 mm
V5

DELPHI **2DL02.Y**



68 mm
V5

DELPHI **2DL03**



88 mm
CVC

VW

DELPHI **2DL04**



88 mm
CVC

OPEL

DELPHI **2DL05**



88 mm
CVC

OPEL

DELPHI **2DL06**



88 mm
5 CVC

FIAT/ALFA ROMEO/LANCIA

DELPHI **2DL08**



89 mm
CVC

OPEL

DELPHI **2DL09**



79,5 mm
CVC

AUDI/SKODA /VW

DELPHI **2DL10**



80 mm

OPEL

DELPHI **2DL11**



HIGH PRESSURE
RELIEF VALVE
(M10*1.25)

DELPHI **2DL12**



53 mm

DENSO **2DN01**



71 mm
5SL12C

FIAT/OPEL

DENSO **2DN02**



92 mm
6SEU12/
6SEU16/
7SEU16

AUDI/SEAT/SKODA/VW

DENSO **2DN03.B**



94 mm
6SEU/
6SEU16/
7SEU16

VW

DENSO **2DN03.Y**



94 mm
6SEU/
6SEU16/
7SEU16

MERCEDES/BMW

DENSO **2DN04**



97 mm
5SE09C/
5SE12C

TOYOTA

DENSO **2DN05**



93 mm
6SEU/
6SEU16/
7SEU16

AUDI/SEAT/SKODA/VW

DENSO **2DN06**



93 mm
6SEU16/
7SEU16

MERCEDES/BMW

DENSO **2DN07**



123 mm
6SEU12C/
6SEU16C

TOYOTA

DENSO **2DN08**



96 mm
6SEU12C/
6SEU16C

AUDI/SEAT/SKODA/VW

DENSO **2DN09**



89 mm
6SE/7SE

BMW

DENSO **2DN10**



50 mm
7SB/7SBU

DENSO **2DN11**



51,5 mm
5SE12

FIAT/OPEL

DENSO **2DN12**



57,5 mm
6C17/
6CA17C/
7SB16C

DENSO **2DN13**



94 mm
7SEU17C

DENSO **2DN14**



97 mm

DENSO **2DN15**



93 mm

CITROEN/PEUGEOT

DENSO **2DN16**



96 mm
5SER09

TOYOTA

DENSO **2DN17**



98 mm

TOYOTA

DENSO **2DN18**



92 mm

TOYOTA

DENSO **2DN20**



86 mm
5SE/6SE

AUDI/SEAT/SKODA/VW

DENSO **2DN21**



65 mm
7SBU16H

LEXUS

DENSO **2DN22**



87 mm

AUDI/ BMW/MERCEDES

DENSO **2DN23**



99 mm
5SE/6SE

CITROEN/PEUGEOT

DENSO **2DN24**



103 mm

CITROEN/PEUGEOT

DENSO **2DN25**



95 mm
5SE/6SE/
7SE

BMW

DENSO **2DN27**



TSB10C

SPEED SENSOR

TOYOTA

DENSO **2DN28**



HIGH PRESSURE RELIEF VALVE (M10*1.5)

DENSO **2DN29**



97mm
7SBH17C

DENSO **2DN30**



119 mm

TOYOTA

DENSO **2DN31**



115 mm

TOYOTA

DENSO **2DN32**



33,5 mm
7SBU16C

HALLA **2HA01**



94 mm
VS16E/
VS18E

HYUNDAI

HALLA **2HA02**



97 mm

HYUNDAI

SCROLL **2SC01**



33 mm

FORD

SANDEN **2SD01**



48 mm
SD6V12/
SD7V16

SANDEN **2SD02**



103 mm
PXE

AUDI/SEAT/SKODA/VW

SANDEN **2SD03**



72 mm
PXE

AUDI/SEAT/SKODA/VW

SANDEN **2SD04**



96 mm
6C16/
7C16

CITROEN/PEUGEOT

SANDEN **2SD05**



101 mm
PXE

AUDI/SEAT/SKODA/VW

SANDEN **2SD06**



103 mm
7C16

CITROEN/PEUGEOT

SANDEN **2SD07**



78 mm
PXE

AUDI/SEAT/SKODA/VW

SANDEN **2SD08**



72 mm
PXE16

AUDI/SEAT/SKODA/VW

SANDEN **2SD09**



88 mm
PXE16

OPEL

SANDEN **2SD10**



78 mm
PXE14

AUDI/SEAT/SKODA/VW

SANDEN **2SD11**



42 mm
PXE16

SANDEN **2SD12**



88 mm
PXE14

NISSAN

SANDEN **2SD13**



44 mm
SD7V16/
SD6V12

FORD/ VW

SANDEN **2SD14**



HIGH PRESSURE RELIEF VALVE (3/8")

SANDEN **2SD16** *NEW!! v.01*



78,6 mm
PX

CITROEN/PEUGEOT

VISTEON **2VI01**



54 mm
VS16

FORD

VISTEON **2VI02**



87 mm

FORD/ VOLVO

VISTEON **2VI03**



55 mm
VS16

FORD/ VOLVO

VISTEON **2VI04**



94 mm
VS16E/
VS18E

FORD

ZEXEL **2ZX01**



97 mm
DCS17E/
DCW17F

AUDI/SEAT/SKODA/VW

ZEXEL **2ZX02**



97 mm
DCS17/
KC-88

MERCEDES

ZEXEL **2ZX03**



44 mm
DCW-17C

AUDI/VW

ZEXEL **2ZX04**



103 mm
KC88/
DCS17E

NISSAN/OPEL/RENAULT

ZEXEL **2ZX05**



38 mm
DKV-10R

SUBARU

ZEXEL **2ZX06**



86 mm
DCS17E

FORD/VOLVO

ZEXEL **2ZX07**



94 mm
DCS17E

MERCEDES

ZEXEL **2ZX08**



87 mm
DCS17E

HYUNDAI/ VW

ZEXEL **2ZX09**



86 mm
VS16E/
VS18E

HYUNDAI

ZEXEL **2ZX10**



87 mm

RENAULT

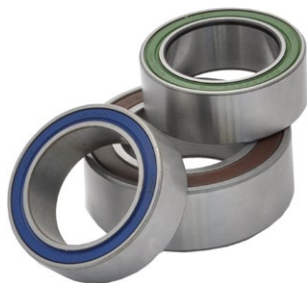

BEARINGS

ŁOZYSKA-ZASTOSOWANIE

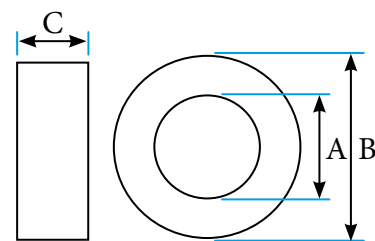

Size AxBxC	Number	Description
Wymiar	Numer	Zastosowanie
10x28x8	AC-03XX30	SANDEN (TRS)
12x28x8	AC-03XX29	FORD (SCROLL)
30x47x12	AC-03XX14	DENSO (SC06)
30x47x18	AC-03XX22	SANDEN (TR70)
30x47x20	AC-03XX15	DENSO (SC06)
30x52x20	AC-03XX16	DENSO (10S11 Series, SCS06C, SCSA06)
30x52x22	AC-03XX01	DENSO (10PA15 Series, 10PA15C - BMW, 10PA15VC, 10PA17 Series, 10PA20 Series, 10S13 Series, 10S15 Series, 10S17 Series, 10S20 Series, TV10 Series, TV12C - R12, TV12C - R134a, TV12EC - R12, TV12SC - R134a, TV14C - R12, TV14EC - R12, TV14SC - R134a)
30x55x23	AC-03XX02	BEHR/BOSCH (Behr Wingcell, Bosch Axial, Bosch Wingcell), DIESEL KIKI (DKS16H - R12, DKS16H - R134a, DKV14B), FORD (FS10, FX15), NIHON (NVR140S), VISTEON (HS15 HS17, HS18, HS20 Series)
30x62x16x24	AC-03XX24	TECUMSEH (HG500, HG850, HG1000), YORK (206, 209, 210, SC206, SC209, YA Series)
30x62x27	AC-03XX25	CHRYSLER (RV2)
32x47x18	AC-03XX13	MATSUSHITA/PANASONIC (H12A1AH4DX), SEIKO-SEIKI (SS10 Series)
32x55x20	AC-03XX28	PANASONIC, ZEXEL
32x55x23	AC-03XX03	MATSUSHITA/PANASONIC (N1301 Series, NL1300 Series, S1150 Series, SA1150AE4), SEIKO-SEIKI (SS96 Series)
35x48x20	AC-03XX20	SANDEN (TRSE07)
35x50x20	AC-03XX04	DELPHI (CVC125, CVC135, CVC135E), HALLA (FS18), MITSUBISHI (MSC130 Series), SANDEN (Scroll, SD7B10, TR090, TRF090, TRS090, TR105, TRF105, TRS105 TRSA12), VISTEON (HS090, HS110 Series)
35x52x12	AC-03XX12	DENSO (5SE09C, 5SE12C, 5SL12CJ, 6SEU16, 7SE16C, 7SEU16C)
35x52x20	AC-03XX05	DENSO (7SE16C, SC08, SC08C), DIESEL KIKI (DCS17C, DCS17D), SANDEN (PXE13, PXE16, PXV16, SD7C16)
35x52x22	AC-03XX06	DELPHI (CVC165, CVC185), DENSO (10PA15C, 10PA17C, 6CA17C, 6SEU12, 7SB16C, 7SBU16C, 7SEU16C)
35x55x20	AC-03XX07	CALSONIC (CR14, CWV615, 617, 618), DIESEL KIKI (DCV11A, DCV14A, DCW17B, DCW17D, DKS13G, DKS13S, DKS15BH, DKS15CH, DKS15G, DKS15S, DKS17CH, DKS17D, DKS17G, DKS17S, DKV11A, DKV11D, DKV11G, DKV14D, DKV14G), HONDA SYSTEM (RC17D, RC17S), MATSUSHITA/PANASONIC (N1301 Series NL1300 Series), SANDEN (SD505, SD5H Series, SD6V12, SD708, SD709 Series SD709CA, SD709CP, SD7H15, SD7V16, TR090, TRF090, TRS090 TRSA09), SEIKO-SEIKI (SS121 Series), TAMA (TM08HD), VISTEON (VS16)
35x55x22	AC-03XX27	VALEO
35x62x24	AC-03XX17	DIESEL KIKI (DCW17B, DCW17D)
35x62x28	AC-03XX08	DIESEL KIKI (DKS15BH, DKS15CH)
38x54x17	AC-03XX09	DENSO (10P08E), GM/HARRISON (SP10)
40x57x20	AC-03XX18	DENSO (10P17 Series, 10P17VC)
40x57x24	AC-03XX26	MITSUBISHI FXA 105
40x62x20,6	AC-03XX10	CALSONIC (V5-15C, V5-15F, V5-15G), DAEWOO (V5), GM/HARRISON (A6, DA6, HD6, HT6, HR6, HR6-HE, HU6, R4 - Lt R4, R4 - Std R4, V5, V7) KEIHIN (150L, 150R)
40x62x20,6x24	AC-03XX23	CHRYSLER (6C17, A590, C171), DENSO (6E171 Series, 6P127 Series, 6P134, 6P148 Series), FORD (FS6), MITSUBISHI (FX105V Series, FX80), TECUMSEH (HR980)
40x62x24	AC-03XX21	CALSONIC (CWV615, 617, 618), DENSO (10P13, 10P15 Series, 10P17 Series, 10P17VC), DIESEL KIKI (DKV14C), HITACHI (A5000, MJS170), MITSUBISHI (MSC105 Series, MSC90 Series), SANDEN (SD507, SD508, SD510), SEIKO-SEIKI (SS170 Series)
40x66x24	AC-03XX11	MITSUBISHI (MSC105 Series, MSC90 Series)
40x68x30	AC-03XX19	TM 31/32

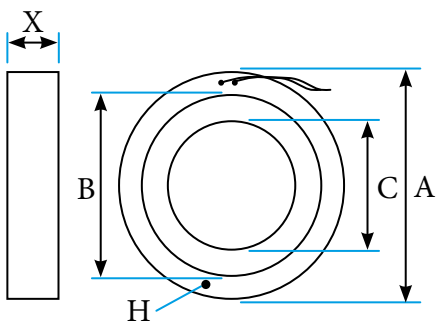

BOCK **4BK01**

A: 206mm B: 145mm
C: 145mm X: 34mm
H: - 24V
 FK4

CALSONIC **4CL01**

A: 96mm B: 64mm
C: 45mm X: 32mm
H: 10:30 12V
 CSE717

BMW

CALSONIC **4CL02**

A: 101mm B: 66mm
C: 45mm X: 28mm
H: 01:15 12V
 DMV615M

NISSAN

CALSONIC **4CL03**

A: 101mm B: 66mm
C: 45mm X: 26mm
H: 03:45 12V
 DMV615M

NISSAN

CALSONIC **4CL04**

A: 101mm B: 66mm
C: 40mm X: 28mm
H: 02:00 12V

NISSAN

CALSONIC **4CL05**

A: 101mm B: 66mm
C: 45mm X: 26mm
H: 06:15 12V
 CR14

CALSONIC **4CL06**

A: 96mm B: 64mm
C: 45mm X: 32mm
H: 06:15 12V

CALSONIC **4CL07**

A: 103mm B: 72mm
C: 50mm X: 30mm
H: 02:50 12V

NISSAN

CALSONIC **4CL08**

A: 92mm B: 60mm
C: 45mm X: 27mm
H: 10:30 12V
 CSV617

NISSAN

CALSONIC **4CL09**

A: 96mm B: 64mm
C: 45mm X: 27mm
H: 10:00 12V
 CSE717

BMW

CALSONIC **4CL10**

A: 101mm B: 66mm
C: 45mm X: 28mm
H: 06:00 12V
 CR-12SC

RENAULT

CALSONIC **4CL11**

A: 97mm B: 64mm
C: 45mm X: 31mm
H: 10:00 12V

CALSONIC **4CL12**

A: mm B: mm
C: mm X: mm
H:

DELPHI **4DL01**

A: 92mm B: 60mm
C: 45mm X: 27mm
H: 10:00 12V
 CVC

OPEL

DELPHI **4DL02**

A: 103mm B: 72mm
C: 52mm X: 36mm
H: - 12V
 V5

OPEL

DELPHI **4DL03**

A: 103mm B: 72mm
C: 52mm X: 36mm
H: - 12V
 V5

RENAULT

DELPHI **4DL04**

A: 96mm B: 63mm
C: 45mm X: 27mm
H: 10:00 12V
 V5

RENAULT

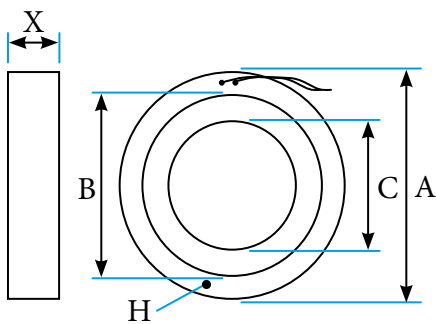

DELPHI **4DL05**
 A: 100mm B: 66mm
 C: 45mm X: 25mm
 H: 10:00 12V
 CVC

RENAULT/NISSAN

DELPHI **4DL06**
 A: 92mm B: 62mm
 C: 39mm X: 25mm
 H: 06:00 12V
 CVC

DAEWOO/HYUNDAI

DELPHI **4DL07**
 A: 103mm B: 72mm
 C: 52mm X: 28mm
 H: - 12V
 V5

GM

DELPHI **4DL08**
 A: 93mm B: 72mm
 C: 52mm X: 32mm
 H: - 12V
 V5

DAEWOO/OPEL

DELPHI **4DL09**
 A: 103mm B: 72mm
 C: 52mm X: 36mm
 H: - 12V
 V5

VW

DELPHI **4DL10**
 A: 97mm B: 63mm
 C: 42mm X: 28mm
 H: 06:00 12V
 CVC

RENAULT

DELPHI **4DL11**
 A: 92mm B: 60mm
 C: 45mm X: 26mm
 H: 10:00 12V
 CVC

CHEVROLET/OPEL

DELPHI **4DL12**
 A: 83mm B: 55mm
 C: 40mm X: 29mm
 H: 03:45 12V
 QS90

CHEVROLET/OPEL

DELPHI **4DL13**
 A: 104mm B: 60mm
 C: 45mm X: 34mm
 H: - 12V
 A6

JAGUAR

DELPHI **4DL14**
 A: 103mm B: 72mm
 C: 52mm X: 36mm
 H: - 12V
 V5

HYUNDAI

DELPHI **4DL15**
 A: 96mm B: 62mm
 C: 40mm X: 25mm
 H: 06:00 12V

CHEVROLET

DELPHI **4DL16**
 A: 96mm B: 63mm
 C: 40mm X: 27mm
 H: 10:00 12V
 CVC

MASERATI

DELPHI **4DL17**
 A: 92mm B: 62mm
 C: 45mm X: 24mm
 H: 10:00 12V
 CVC

ALFA ROMEO, FIAT

DELPHI **NEW!!! 4DL18**
 A: 92mm B: 62mm
 C: 42mm X: 25mm
 H: 05:00 12V
 CSP11

CHEVROLET/OPEL

DENSO **4DN01**
 A: 97mm B: 62mm
 C: 40mm X: 28mm
 H: 06:00 12V
 7SB/7SBU
 10PA15/17/20

VW

DENSO **4DN02**
 A: 97mm B: 62mm
 C: 40mm X: 28mm
 H: 06:00 12V
 7SB/7SBU

VW

DENSO **4DN03**
 A: 97mm B: 62mm
 C: 40mm X: 28mm
 H: 06:00 12V
 10PA/7SBU

BMW/MERCEDES

DENSO **4DN04**
 A: 80mm B: 55mm
 C: 40mm X: 25mm
 H: 06:00  12V
 10S08

TOYOTA

DENSO **4DN05**
 A: 96mm B: 61mm
 C: 40mm X: 25mm
 H: 06:15  12V
 10S

TOYOTA

DENSO **4DN06**
 A: 96mm B: 61mm
 C: 40mm X: 25mm
 H: 06:00  12V
 10S11/13/15/17

HONDA/TOYOTA

DENSO **4DN07**
 A: 87mm B: 60mm
 C: 40mm X: 25mm
 H: 06:00  12V
 SCS06/SCSA06

FIAT/TOYOTA

DENSO **4DN08**
 A: 96mm B: 62mm
 C: 40mm X: 28mm
 H: 06:00  12V
 10PA

KIA/HYUNDAI

DENSO **4DN09**
 A: 97mm B: 66mm
 C: 50mm X: 34mm
 H: 12:30  12V
 10P17

AUDI/VW

DENSO **4DN10**
 A: 97mm B: 62mm
 C: 40mm X: 25mm
 H: 06:15  12V

AUDI

DENSO **4DN11**
 A: 97mm B: 61mm
 C: 40mm X: 22mm
 H: 06:15  12V
 6SAS14C

AUDI

DENSO **4DN12**
 A: 96mm B: 61mm
 C: 40mm X: 25mm
 H: 06:30  12V
 6SAS

MERCEDES

DENSO **4DN13**
 A: 96mm B: 61mm
 C: 40mm X: 22mm
 H: 06:30  12V
 6SAS

MERCEDES

DENSO **4DN14**
 A: 96mm B: 61mm
 C: 40mm X: 22mm
 H: 06:30  12V
 6SAS

MERCEDES/NISSAN

DENSO **4DN15**
 A: 97mm B: 61mm
 C: 40mm X: 25mm
 H: 06:30  12V
 6SAS

MERCEDES

DENSO **4DN16**
 A: 97mm B: 61mm
 C: 40mm X: 22mm
 H: 06:30  12V
 6SAS14C

AUDI

DENSO **4DN17**
 A: 96mm B: 61mm
 C: 40mm X: 25mm
 H: 06:30  12V

MERCEDES

DENSO **4DN18**
 A: 87mm B: 59mm
 C: 40mm X: 25mm
 H: 06:00  12V
 10S11C

TOYOTA

DENSO **4DN19**
 A: 97mm B: 61mm
 C: 40mm X: 22mm
 H: 06:30  12V

FIAT

DENSO **4DN30**
 A: 80mm B: 55mm
 C: 40mm X: 22mm
 H: 06:00  12V
 SV07C

DAIHATSU

DENSO **NEW!!! 4DN31**
 A: 96mm B: 61mm
 C: 40mm X: 22mm
 H: 06:15  12V

FORD

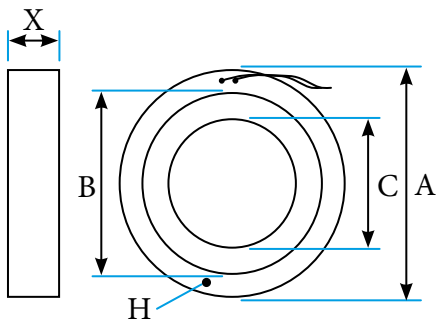

DENSO ^{NEW!!!} **4DN32**
 A: 96mm B: 62mm
 C: 40mm X: 25mm
 H: 06:15 12V
 7SBH17C

FORD

FORD FS **4FS01**
 A: 95mm B: 64mm
 C: 64mm X: 36mm
 H: - 12V
 FS/FX

FORD

FORD FS **4FS02**
 A: 101mm B: 66mm
 C: 64mm X: 34mm
 H: - 12V
 FS/FX

FORD

FORD FS **4FS03**
 A: 115mm B: 64mm
 C: 64mm X: 29mm
 H: - 12V
 FS/FX

FORD

HALLA **4HA01**
 A: 101mm B: 66mm
 C: 64mm X: 36mm
 H: - 12V
 HS15/16/17/18

KIA/HYUNDAI

HALLA **4HA02**
 A: 100mm B: 60mm
 C: 45mm X: 27mm
 H: 03:20 12V
 HS15

KIA/HYUNDAI

HALLA **4HA03**
 A: 98mm B: 63mm
 C: 63mm X: 35mm
 H: - 12V
 HS18

HYUNDAI

HALLA **4HA04**
 A: 101mm B: 66mm
 C: 64mm X: 36mm
 H: - 12V

KIA

HALLA **4HA05**
 A: 96mm B: 62mm
 C: 45mm X: 32mm
 H: 08:15 12V

KIA

HALLA **4HA06**
 A: 100mm B: 60mm
 C: 45mm X: 27mm
 H: 03:30 12V

KIA

HALLA **4HA07**
 A: 91mm B: 61mm
 C: 45mm X: 29mm
 H: 02:30 12V

KIA/HYUNDAI

HALLA **4HA08**
 A: 96mm B: 62mm
 C: 45mm X: 28mm
 H: 08:30 12V

KIA/HYUNDAI

HALLA **4HA09**
 A: 101mm B: 66mm
 C: 64mm X: 35mm
 H: - 12V
 FORD FS/FX
 HCC

FORD

HALLA ^{NEW!!!} **4HA10**
 A: 91mm B: 59mm
 C: 40mm X: 27mm
 H: 06:00 12V
 DV9

SEAT, SKODA, VOLKSWAGEN

KEIHIN **4KE01**
 A: 86mm B: 59mm
 C: 45mm X: 32mm
 H: 05:00 12V
 HS-110R

HONDA CR-V

KEIHIN **4KE02**
 A: 86mm B: 59mm
 C: 45mm X: 32mm
 H: 05:00 12V
 HS-110R

HONDACRV

KEIHIN **4KE03**
 A: 96mm B: 64mm
 C: 45mm X: 33mm
 H: 05:30 12V
 HS-110R

HONDA



KEIHIN **4KE04**

A: 86mm B: 57mm
C: 45mm X: 33mm
H: 05:30  12V
 TRS



HONDA

mitsubishi **4MI01**

A: 83mm B: 57mm
C: 40mm X: 31mm
H: 03:30  12V
 MSC



MITSUBISHI

MITSUBISHI **4MI02**

A: 83mm B: 58mm
C: 45mm X: 30mm
H: 04:30  12V
 MSC



MITSUBISHI

MITSUBISHI **4MI03**

A: 83mm B: 55mm
C: 40mm X: 28mm
H: 03:00  12V
 MSC



MITSUBISHI

MITSUBISHI **4MI04**

A: 87mm B: 62mm
C: 39mm X: 26mm
H: -  12V



MITSUBISHI

MITSUBISHI **4MI05**

A: 78mm B: 58mm
C: 40mm X: 27mm
H: 01:30  12V
 MSC60



SUZUKI

PANASONIC **4PA01**

A: 101mm B: 66mm
C: 42mm X: 32mm
H: -  12V



MAZDA

PANASONIC **4PA02**

A: 112mm B: 66mm
C: 42mm X: 32mm
H: -  12V



MAZDA3/6

PANASONIC **4PA03**

A: 122mm B: 66mm
C: 42mm X: 32mm
H: -  12V



MAZDA

PANASONIC **4PA04**

A: 88mm B: 59mm
C: 42mm X: 33mm
H: 12:00  12V



MAZDA

PANASONIC **4PA05**

A: 101mm B: 57mm
C: 40mm X: 32mm
H: 02:30  12V



MAZDA

PANASONIC **4PA06**

A: 96mm B: 58mm
C: 40mm X: 25mm
H: 03:30  12V



MAZDA

PANASONIC **4PA07**

A: 96mm B: 64mm
C: 42mm X: 33mm
H: -  12V



MAZDA

PANASONIC **4PA08**

A: 101mm B: 66mm
C: 42mm X: 33mm
H: 12:00  12V



MAZDA6

PANASONIC **4PA09**

A: 96mm B: 58mm
C: 40mm X: 25mm
H: 03:30  12V



SUZUKI



SCROLL **4SC01**

A: 84mm B: 58mm
C: 45mm X: 34mm
H: 06:00,09:00  12V
 SCROLL



FORD

SANDEN **4SD01**

A: 103mm B: 64mm
C: 45mm X: 32mm
H: 05:30  12V
 SD7V16



AUDI/SEAT/SKODA/VW

SANDEN **4SD02**

A: 86mm B: 59mm
C: 45mm X: 31mm
H: 05:30  12V
 SD6V12



OPEL

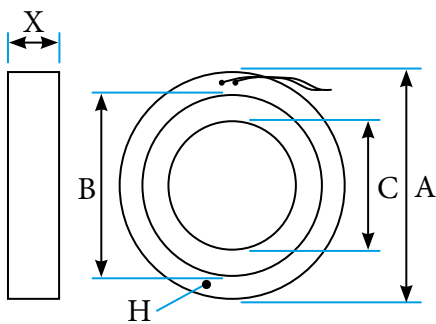

SANDEN

4SD03



A: 103mm B: 64mm
C: 45mm X: 27mm
H: 05:30 12V
 SD7V16

VW

SANDEN

4SD04



A: 96mm B: 61mm
C: 45mm X: 28mm
H: 09:00 12V
 SD7V16

OPEL

SANDEN

4SD05



A: 96mm B: 61mm
C: 45mm X: 28mm
H: 05:30 12V
 PXV

OPEL

SANDEN

4SD06



A: 96mm B: 61mm
C: 45mm X: 26mm
H: 09:00 12V
 SD6V12

CITROEN/PEUGEOT

SANDEN

4SD07



A: 96mm B: 64mm
C: 45mm X: 32mm
H: 09:15 12V
 SD7V16

CITROEN/PEUGEOT

SANDEN

4SD08



A: 96mm B: 64mm
C: 45mm X: 32mm
H: 05:25 12V
 SD7H15

SANDEN

4SD09



A: 96mm B: 64mm
C: 45mm X: 33mm
H: 05:30 12V
 SD7V16/SD6V12

CITROEN/PEUGEOT/FIAT/RENAULT

SANDEN

4SD10



A: 103mm B: 64mm
C: 45mm X: 32mm
H: 05:20 12V
 SD7V16

AUDI/SEAT/SKODA/VW

SANDEN

4SD11



A: 96mm B: 64mm
C: 45mm X: 30mm
H: 05:30 12V

SANDEN

4SD12



A: 86mm B: 58mm
C: 45mm X: 36mm
H: 05:30 12V
 TRS

HONDA

SANDEN

4SD13



A: 96mm B: 64mm
C: 45mm X: 32mm
H: 05:25 12V

CITROEN/PEUGEOT

SANDEN

4SD14



A: 103mm B: 72mm
C: 51mm X: 39mm
H: 05:30 12V
 SD7V16

SANDEN

4SD15



A: 103mm B: 61mm
C: 45mm X: 33mm
H: 06:00 12V
 SD6C12

CITROEN/PEUGEOT

SANDEN

4SD16



A: 96mm B: 61mm
C: 45mm X: 33mm
H: 06:00 12V
 SD6C12

CITROEN/PEUGEOT

SANDEN

4SD17



A: 81mm B: 58mm
C: 45mm X: 34mm
H: 05:30 12V
 TRS09

HONDA

SANDEN

4SD18



A: 86mm B: 59mm
C: 45mm X: 31mm
H: 05:00 12V
 TRS09

HONDA



SANDEN

4SD19



A: 86mm B: 59mm
C: 45mm X: 33mm
H: 05:30 12V
 TRS09

OPEL



SANDEN **4SD30**

 A: 86mm B: 59mm
 C: 45mm X: 34mm
 H: 06:30  12V
 SD6V12
SEAT/SKODA/VW

SANDEN **4SD31**

 A: 113mm B: 72mm
 C: 45mm X: 33mm
 H: 05:30  12V
 SD7H15
SPECIAL VEHICLES

SANDEN **4SD32**

 A: 103mm B: 61mm
 C: 45mm X: 28mm
 H: 05:30  12V
 PX
OPEL

SANDEN **4SD33**

 A: 96mm B: 61mm
 C: 45mm X: 28mm
 H: 05:30  12V
 PX
VOLVO/FORD/JAGUAR/LAND ROVER

SANDEN **4SD34**

 A: 103mm B: 61mm
 C: 45mm X: 33mm
 H: 06:00  12V
 SD7V16
VW

SANDEN **4SD35**

 A: 86mm B: 59mm
 C: 45mm X: 33mm
 H: 05:30  12V
 TRS
HONDA

SANDEN **4SD36**

 A: 96mm B: 61mm
 C: 45mm X: 29mm
 H: 05:30  12V
 PXC14
MERCEDES

SANDEN **4SD37**

 A: 91mm B: 59mm
 C: 45mm X: 32mm
 H: 10:00  12V
 HS110R/
 TRSE07
HONDA

SANDEN **4SD38**

 A: 97mm B: 55mm
 C: 40mm X: 25mm
 H: 07:30  12V
 TRSE09/
 TRSA09
HONDA

SANDEN **4SD39**

 A: 96mm B: 61mm
 C: 45mm X: 28mm
 H: 05:30  12V
FORD

SANDEN **4SD40**

 A: 96mm B: 64mm
 C: 45mm X: 32mm
 H: 05:30  12V
 SD505/SD507
SPEC.VEH.

SANDEN **4SD41**

 A: 96mm B: 61mm
 C: 45mm X: 33mm
 H: 06:00  12V
FORD

SANDEN **4SD42**

 A: 96mm B: 61mm
 C: 45mm X: 28mm
 H: 09:00  12V
FIAT

SANDEN **4SD43**

 A: 96mm B: 61mm
 C: 45mm X: 28mm
 H: 09:00  12V
OPEL

SANDEN **NEW!!! 4SD44**

 A: 103mm B: 64mm
 C: 45mm X: 32mm
 H: 10:30  12V
PEUGEOT, CITROEN

SEIKO-SEIKI **4SS01**

 A: 86mm B: 55mm
 C: 40mm X: 23mm
 H: 09:00  12V
BMW/SUZUKI

SEIKO-SEIKI **4SS02**

 A: 96mm B: 64mm
 C: 40mm X: 27mm
 H: 08:00  12V
BMW

SEIKO-SEIKI **4SS03**

 A: 96mm B: 64mm
 C: 40mm X: 27mm
 H: 08:30  12V
 SS1201
BMW

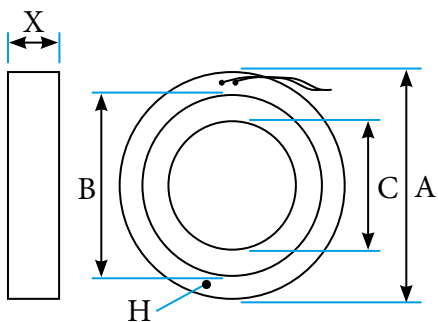

SEIKO-SEIKI **4SS04**
 A: 92mm B: 55mm
 C: 40mm X: 24mm
 H: 07:30 12V
CITROEN/PEUGEOT

UNICLA **4UN01** *NEW!!!*
 A: 111mm B: 66mm
 C: 44mm X: 31mm
 H: 02:00 12V
 UP200
SPECIAL VEHICLES

VISTEON **4VI01**
 A: 97mm B: 64mm
 C: 45mm X: 31mm
 H: 12:00 12V
 VS16
FORD

VISTEON **4VI02**
 A: 101mm B: 66mm
 C: 45mm X: 30mm
 H: 12:00 12V
 VS16
FORD

VISTEON **4VI03**
 A: 101mm B: 66mm
 C: 45mm X: 30mm
 H: 12:00 12V
 VS16
FORD

VISTEON **4VI04**
 A: 97mm B: 64mm
 C: 45mm X: 31mm
 H: 12:00 12V
 VS16
FORD

VISTEON **4VI05**
 A: 97mm B: 63mm
 C: 42mm X: 28mm
 H: 06:00 12V
 VS
FORD

VISTEON **4VI06**
 A: 97mm B: 64mm
 C: 45mm X: 31mm
 H: 12:00 12V
 VS16
FORD

YORK **4YO01**
 A: 117mm B: 67mm
 C: 67mm X: 40mm
 H: - 12V
 ER210R
FORD

YORK **4YO02**
 A: 117mm B: 75mm
 C: 75mm X: 39mm
 H: - 12V
 ER210R
FORD

ZEXEL **4ZX01**
 A: 101mm B: 66mm
 C: 40mm X: 28mm
 H: 01:30 12V
 TM 08/11/13/15/16
FORD

ZEXEL **4ZX02**
 A: 101mm B: 66mm
 C: 45mm X: 27mm
 H: 01:00 12V
 DSC17/KC88
OPEL/RENAULT/NISSAN

ZEXEL **4ZX03**
 A: 96mm B: 64mm
 C: 45mm X: 33mm
 H: 01:00 12V
 KC-88
VOLVO

ZEXEL **4ZX04**
 A: 105mm B: 66mm
 C: 40mm X: 28mm
 H: 02:50 12V
 DKS17
VOLVO

ZEXEL **4ZX05**
 A: 100mm B: 66mm
 C: 45mm X: 27mm
 H: 01:00 12V
 DCS17
NISSAN

ZEXEL **4ZX06**
 A: 101mm B: 66mm
 C: 40mm X: 29mm
 H: 02:30 12V

NISSAN

ZEXEL **4ZX07**
 A: 86mm B: 55mm
 C: 40mm X: 23mm
 H: 09:00 12V
 DKV08R
NISSAN

ZEXEL **4ZX08**

A: 105mm B: 65mm
C: 40mm X: 37mm
H: 03:00  12V
 DKS-15D

FORD/VOLVO

ZEXEL **4ZX09**

A: 85mm B: 55mm
C: 40mm X: 26mm
H: 09:00  12V
 DKV-08R



SUZUKI

ZEXEL **4ZX10**

A: 85mm B: 55mm
C: 40mm X: 25mm
H: 09:00  12V

SUZUKI

ZEXEL **4ZX11**

A: 105mm B: 65mm
C: 45mm X: 30mm
H: 01:00  12V
 DCW-17D

AUDI/FORD/SEAT/SKODA/WV

ZEXEL **4ZX12**

A: 96mm B: 64mm
C: 45mm X: 34mm
H: 01:00  12V

SUZUKI

ZEXEL **4ZX13**

A: 122mm B: 66mm
C: 40mm X: 22mm
H: 02:00  12V
 DKS-17D

NISSAN

ZEXEL **4ZX14**

A: 101mm B: 66mm
C: 45mm X: 29mm
H: 01:00  12V
 DCW17



AUDI/VW

ZEXEL **4ZX15**

A: 112mm B: 66mm
C: 40mm X: 22mm
H: 09:30  12V
 DCS-17EC

RENAULT

ZEXEL **4ZX16**

A: 96mm B: 64mm
C: 40mm X: 33mm
H: 02:00  12V
 DKS15D

MITSUBISHI

ZEXEL **4ZX17**

A: 101mm B: 66mm
C: 40mm X: 28mm
H: 02:00  12V
 DKS17D

NISSAN

ZEXEL **4ZX18**

A: 96mm B: 64mm
C: 40mm X: 25mm
H: 09:00  12V

SUBARU

ZEXEL **4ZX19**

A: 104mm B: 66mm
C: 45mm X: 29mm
H: 01:30  12V
 KC-88

VOLVO

ZEXEL **NEW!!! 4ZX26**

A: 96mm B: 64mm
C: 45mm X: 30mm
H: 09:00  12V
 VCS 14EC

NISSAN, RENAULT

ZEXEL **4ZX30**

A: 96mm B: 64mm
C: 40mm X: 31mm
H: 02:00  12V

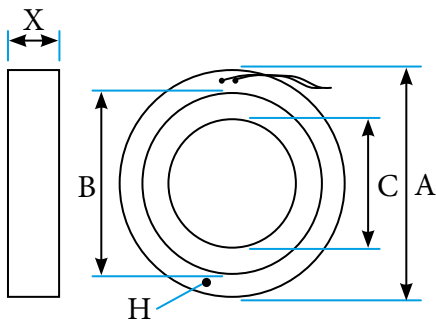

ZEXEL

4DL20



A: 103mm B: 72mm
C: 52mm X: 36mm
H: - 24V
 V5

SPECIAL VEHICLES

DELPHI

4DL21



A: 104mm B: 60mm
C: 45mm X: 34mm
H: - 24V
 A6

SPECIAL VEHICLES

DENSO

4DN20



A: 96mm B: 62mm
C: 40mm X: 28mm
H: 06:00 24V
 7SB/7SBU
10PA15/17/20

SPECIAL VEHICLES

SANDEN

4SD20



A: 103mm B: 72mm
C: 50mm X: 39mm
H: 05:30 24V
 SD7H15

SPECIAL VEHICLES

SANDEN

4SD21



A: 96mm B: 64mm
C: 45mm X: 32mm
H: 05:30 24V
 SD7H15

SPECIAL VEHICLES

SANDEN

4SD22



A: 96mm B: 64mm
C: 45mm X: 32mm
H: 05:30 24V
 SD7H15

VOLVO

SANDEN

4SD23



A: 113mm B: 72mm
C: 45mm X: 33mm
H: 05:30 24V
 SD7H15

SPECIAL VEHICLES

SANDEN

4SD24



A: 103mm B: 64mm
C: 45mm X: 32mm
H: 05:30 24V
 SD7H15

SPECIAL VEHICLES

UNICLA

NEW!!!
4UN20



A: 111mm B: 66mm
C: 44mm X: 31mm
H: 06:30 24V
 UP200

SPECIAL VEHICLES

YORK

4YO20



A: 117mm B: 67mm
C: 67mm X: 40mm
H: 07:30 24V
 ER210R

SPECIAL VEHICLES

ZEXEL

4ZX20

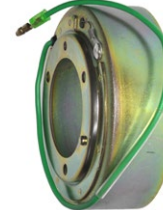

A: 103mm B: 72mm
C: 50mm X: 39mm
H: 05:30 24V
 SD5H14

SPECIAL VEHICLES

ZEXEL

4ZX21



A: 101mm B: 66mm
C: 40mm X: 28mm
H: 01:30 24V
 TM/08/11/13/
15/16

SPECIAL VEHICLES

ZEXEL

4ZX22



A: 105mm B: 66mm
C: 40mm X: 28mm
H: 02:45 24V
 DKS17

SPECIAL VEHICLES

ZEXEL

4ZX23



A: 101mm B: 66mm
C: 40mm X: 28mm
H: 01:30 24V
 TM/08/11/13/
15/16

SPECIAL VEHICLES

ZEXEL

4ZX24



A: 121mm B: 79mm
C: 50mm X: 43mm
H: 02:00 24V
 DKS320/TM31

SPECIAL VEHICLES

ZEXEL

4ZX25



A: 111mm B: 66mm
C: 40mm X: 32mm
H: 03:00 24V
 TM21HD

SPECIAL VEHICLES

COILS

Elektromagnesy - tabela

	A Out. Diam. Wymiar zewnątrzny	B In. Diam wymiar wewnętrzny	C Mounting hole diam. Średnica osadzenia	X Height wysokość cewki	H Clock sposób montażu (clock)
12 V					
4MI05	78	58	40	27	01:30
4DN04	80	55	40	24,8	06:00
4DN30	80	55	40	22	06:00
4SD17	81	58	45	34	05:30
4DL12	83	55	40	29	03:45
4MI03	83	55,4	40	27,8	03:00
4MI01	83	57	40	31	03:30
4MI02	83	57,6	45	29,6	04:30
4SC01	84	58	45	34,2	06:00,09:00
4ZX10	85	55	40	25	09:00
4ZX09	85	55	40	26	09:00
4SS01	86	55	40	23	09:00
4ZX07	86	55	40	23	09:00
4SD02	86	59	45	31	05:30
4SD18	86	59	45	31	05:00
4KE01	86	59	45	32	05:00
4KE02	86	59	45	32	05:00
4SD19	86	59	45	33	05:30
4SD35	86	59	45	33	05:30
4SD30	86	59	45	34	06:30
4KE04	86,2	57,1	45	33,3	05:30
4SD12	86,2	58	45	35,5	05:30
4DN18	87	59	40	25	06:00
4DN07	87	60	40	25	06:00
4MI04	87,1	62,1	39	26	-
4PA04	88	59	42	33	12:00
4HA10	91	58,8	40	27,4	06:00
4SD37	91	58,8	45	31,6	10:00
4HA07	91	61	45	29	02:30
4DL18	91,5	61,5	42	25,3	05:00
4DL17	91,6	62,4	45	24,2	10:00
4DL01	91,8	60	45	26,6	10:00
4SS04	92	55	40	24	07:30
4DL11	92	60	45	26	10:00
4CL08	92	60	45	27	10:30
4DL06	92	62	39	25	06:00
4CL12	92	62	42	25	06:00
4DL08	92,6	71,5	51,8	32,1	-
4FS01	95	63,5	63,8	35,5	-
4ZX18	95,6	64	40	25	09:00
4ZX16	95,7	64	40	32,5	02:00
4PA06	95,8	58,2	40	25	03:30
4PA09	96	58	40	25	03:30
4DN13	96	61	40	22	06:30
4DN14	96	61	40	22	06:30
4DN05	96	61	40	25	06:15
4DN06	96	61	40	25	06:00
4DN12	96	61	40	25	06:30
4SD06	96	61	45	26	09:00
4SD42	96	61	45	27,5	09:00
4SD04	96	61	45	27,6	09:00
4SD05	96	61	45	27,6	05:30
4SD39	96	61	45	28	05:30
4SD33	96	61	45	28	05:30
4SD36	96	61	45	29	05:30
4SD16	96	61	45	33	06:00
4SD41	96	61	45	33	06:00
4SD43	96	61	45	27,5	09:00
4DL15	96	61,7	40	24,5	06:00

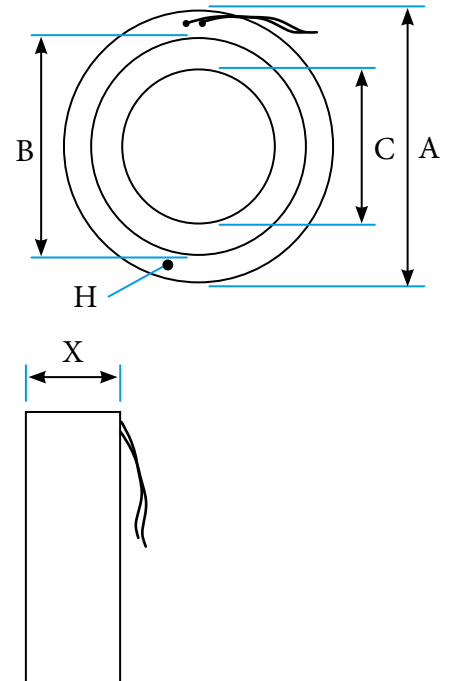

COILS

Elektromagnesy - tabela

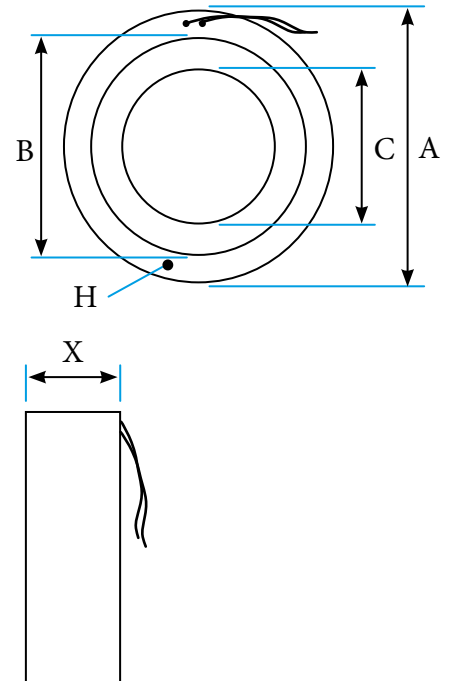

	A ▼ Out. Diam. Wymiar zewnątrzny	B In. Diam wymiar wewnętrzny	C Mounting hole diam. Średnica osadzenia	X Height wysokość cewki	H Clock sposób montażu (clock)
12 V					
4HA08	96	62	45	28	08:30
4SS02	96	64	40	27	08:00
4SS03	96	64	40	27	08:30
4ZX30	96	64	40	31	02:00
4PA07	96	64	42	33	-
4CL09	96	64	45	27	10:00
4SD11	96	64	45	30	05:30
4CL06	96	64	45	31,5	06:15
4CL01	96	64	45	32	10:30
4SD07	96	64	45	32	09:15
4SD08	96	64	45	32	05:25
4SD13	96	64	45	32	05:25
4sd40	96	64	45	32	05:30
4SD09	96	64	45	32,5	05:30
4ZX03	96	64	45	33	01:00
4ZX12	96	64	45	33,5	01:00
4ZX26	96	64	45	30	09:00
4KE03	96	64,3	45	32,5	05:30
4DL04	96,2	62,5	45	27,2	10:00
4DN17	96,3	60,8	40	25	06:30
4HA05	96,3	61,7	45	32	08:15
4DN31	96,4	61	40	21,6	06:15
4DN08	96,4	61,6	40	27,6	06:00
4DN32	96,4	61,8	40	25	06:15
4DL16	96,4	63	40	27,4	10:00
4DN19	96,5	61	40	21,5	06:30
4DN16	96,5	61	40	22	06:30
4DN15	96,5	61	40	25	06:30
4DN10	96,5	61,8	40	24,8	06:15
4CL11	96,5	64	45	31,2	10:00
4DN11	96,6	60,8	40	21,7	06:15
4DN01	96,6	61,5	40	27,5	06:00
4DN02	96,6	61,5	40	27,5	06:00
4DN03	96,6	61,5	40	27,5	06:00
4VI05	96,6	62,5	42	28	06:00
4SD38	96,7	55	40	25	07:30
4DL10	97	63	42	28	06:00
4VI01	97	63,5	45	31	12:00
4VI04	97	64	45	31	12:00
4VI06	97	64	45	31,2	12:00
4DN09	97	66	50	33,5	12:30
4HA03	98	63	63	35	-
4HA02	100	60	45	26,5	03:20
4HA06	100	60	45	26,5	03:30
4DL05	100	66	45	25	10:00
4ZX05	100	66	45	27	01:00
4CL05	100,8	66	45	26	06:15
4HA04	100,8	66	63,8	35,5	-
4CL04	100,9	66	40	28	02:00
4CL03	100,9	66	45	26	03:45
4PA05	101	57,4	40	32,3	02:30
4ZX01	101	66	40	28	01:30
4ZX17	101	66	40	28	02:00
4ZX06	101	66	40	28,5	02:30
4PA01	101	66	42	32	-
4PA08	101	66	42	32,5	12:00
4ZX02	101	66	45	27,2	01:00
4CL10	101	66	45	27,5	06:00
4CL02	101	66	45	27,6	01:15

COILS

Elektromagnesy - tabela

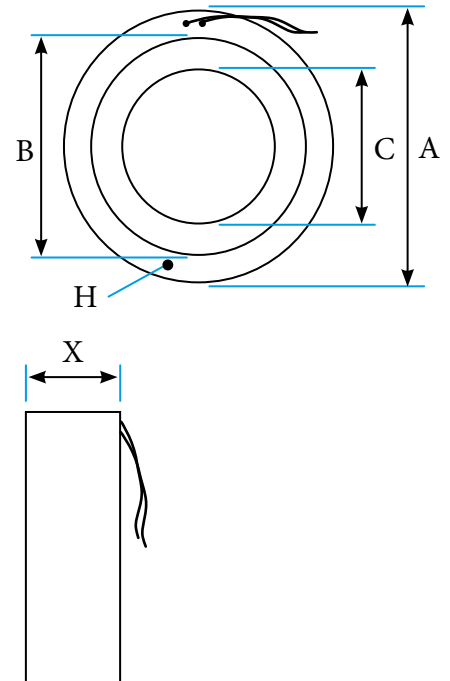

	A Out. Diam. Wymiar zewnątrzny	B In. Diam wymiar wewnętrzny	C Mounting hole diam. Średnica osadzenia	X Height wysokość cewki	H Clock sposób montażu (clock)
12 V					
4ZX14	101	66	45	28,9	01:00
4VI02	101	66	45	29,5	12:00
4VI03	101	66	45	29,5	12:00
4FS02	101	66	63,8	34	-
4HA01	101	66	63,8	35,5	-
4HA09	101	66	64	35	-
4SD32	103	61	45	28	05:30
4SD15	103	61	45	33	06:00
4SD34	103	61	45	33	06:00
4SD03	103	64	45	27,2	05:30
4SD01	103	64	45	32	05:30
4SD10	103	64	45	32	05:20
4SD44	103	64	45	32	10:30
4CL07	103	72	50	30	02:50
4SD14	103	72	50,5	38,5	05:30
4DL02	103	72	51,6	35,5	-
4DL07	103	72	52	28	-
4DL03	103	72	52	35,5	-
4DL14	103	72	52	36	-
4DL09	103	72,1	51,8	35,5	-
4DL13	104	60	45	34	-
4ZX19	104	66	45	29	01:30
4ZX08	105	65	40	37	03:00
4ZX11	105	65	45	30	01:00
4ZX04	105	66	40	28	02:50
4UN01	111	66	44,3	31,2	02:00
4ZX15	111,5	66	40	21,9	09:30
4PA02	111,5	66	42	32	-
4SD31	113	72	45	33	05:30
4FS03	115	63,5	63,8	29,4	-
4YO01	116,5	67	67	40	-
4YO02	116,5	74,5	74,5	38,5	-
4ZX13	122	66	40	22	02:00
4PA03	122	66	42	32	-
4BK01	206	145	145	34	-
24 V					
4SD21	96	64	45	31,6	05:30
4SD22	96	64	45	32	05:30
4DN20	96,2	61,5	40	27,5	06:00
4ZX23	101	66	40	27,7	01:30
4ZX21	101	66	40	28	01:30
4SD24	103	64	45	32	05:30
4SD20	103	72	50	38,5	05:30
4ZX20	103	72	50	39	05:30
4DL20	103	72	52	36	-
4DL21	104	60	45	34	-
4ZX22	105	66	40	28	02:45
4ZX25	111	66	40	31,5	02:00
4UN20	111	66	44,3	31,2	02:00
4SD23	113	72	45	33	05:30
4YO20	116,5	67	67	40	02:00
4ZX24	121	79	50	43	05:30

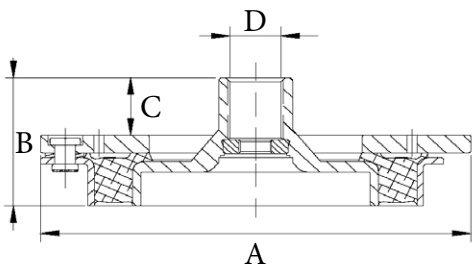

CALSONIC **5CL01**
 A: 109,5 mm
 B: 32,7 mm
 C: 15,7 mm

BMW

CALSONIC **5CL02**
 A: 115 mm
 B: 21,2 mm
 C: 11,2 mm

NISSAN
 CWV618

CALSONIC **5CL03**
 A: 110 mm
 B: 19 mm
 C: 10 mm

NISSAN
 CWV615M

CALSONIC **5CL04**
 A: 110 mm
 B: 16,5 mm
 C: 6 mm

NISSAN
 CWV615M

CALSONIC **5CL05**
 A: 90 mm
 B: 21 mm
 C: 13 mm

BMW
 CSE717

CALSONIC **5CL06**
 A: 115 mm
 B: 21 mm
 C: 10 mm

NISSAN
 CWV618

CALSONIC **5CL07**
 A: 104,1 mm
 B: 22,5 mm
 C: 12 mm

NISSAN
 CSV617

CALSONIC **5CL08**
 A: 105,2 mm
 B: 43 mm
 C: 30,6 mm

RENAULT
 CR-12SC

CALSONIC **5CL09**
 A: 110,8 mm
 B: 37,5 mm
 C: 20 mm

CHEVROLET

DELPHI **5DL01**
 A: 90 mm
 B: 19,5 mm
 C: 9,5 mm

OPEL
 CVC

DELPHI **5DL02**
 A: 105 mm
 B: 26 mm
 C: 13,3 mm

OPEL
 CVC

DELPHI **5DL03**
 A: 90 mm
 B: 19,5 mm
 C: 10 mm

VW
 CVC

DELPHI **5DL04**
 A: 110 mm
 B: 23 mm
 C: 10,2 mm

RENAULT/NISSAN
 CVC

DELPHI **5DL05**
 A: 86 mm
 B: 25 mm
 C: 15 mm

OPEL
 ZJ/ZL/ZM/
 ZK2

DELPHI **5DL06**
 A: 128 mm
 B: 32 mm
 C: 23,2 mm

V5

DELPHI **5DL07**
 A: 120 mm
 B: 34 mm
 C: 23,2 mm

V5

DELPHI **5DL08**
 A: 111 mm
 B: 34 mm
 C: 23,2 mm

V5

DELPHI **5DL09**



A: 108 mm
B: 21 mm
C: 10 mm

 SP17

CHEVROLET

DELPHI **5DL10**



A: 105 mm
B: 28 mm
C: 12,2 mm

 CVC

OPEL/CHEVROLET

DELPHI **5DL11**



A: 75 mm
B: 19 mm
C: -

 DH5

AUDI/ SEAT/SKODA/ VW

DELPHI **5DL12**



A: 92 mm
B: 11 mm
C: 2,2 mm

 QS90

OPEL

DELPHI **5DL13**



A: 118 mm
B: 51 mm
C: 28,5 mm

 A6

AUDI/ FORD/ MB/JAGUAR/SPEC. VEH.

DELPHI **5DL14**



A: 105 mm
B: 24 mm
C: 13,4 mm

 CVC

OPEL

DELPHI **5DL15**

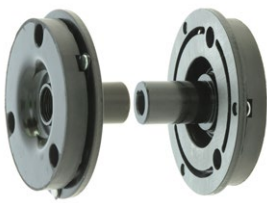

A: 117,5 mm
B: 62,5 mm
C: 41,2 mm

 HARRISON GMA6

SPEC.VEH.

DELPHI **5DL16**



A: 105 mm
B: 29 mm
C: 10 mm

CHEVROLET

DENSO **5DN01**



FOR 5DN04
(HIGHER
17,3mm)

 6SEU/7SEU

DENSO **5DN02**



A: -
B: -
C: -

 5SL, 5SE, 6SEU, 7SEU

DENSO **5DN03**



A: 83 mm
B: 19,6 mm
C: -

 5SL, 5SE, 6SEU, 7SEU

DENSO **5DN04**



A: 74,5 mm
B: 22,3 mm

FOR 5DN01
6SEU, 7SEU

 6SEU, 7SEU

DENSO **5DN05**



FOR 5DN06
(LOWER
14,5mm)

 6SEU/7SEU

DENSO **5DN06**



A: 74,5 mm
B: 22,3 mm

FOR 5DN05
6SEU/7SEU

 6SEU/7SEU

DENSO **5DN07**



A: 83 mm
B: 19,2 mm
C: -

 6SEU, 5SL, 5SE

BMW/TOYOTA

DENSO **5DN08**



A: -
B: -
C: -

 6SEU, 5SL, 5SE

BMW/TOYOTA

DENSO **5DN09**



A: 84 mm
B: 30 mm
C: -

 6SEU, 5SL, 5SE

AUDI

DENSO **5DN10**



A: 85,5 mm
B: 29 mm
C: -

 6SEU/7SEU

MERCEDES

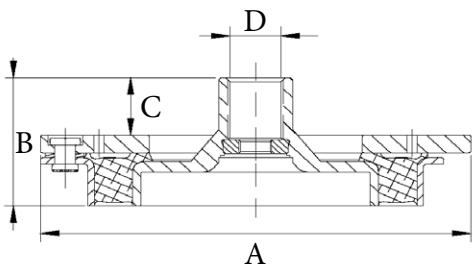

DENSO **5DN11**

A: 83 mm
B: 31,6 mm
C: -

5SL, 5SE

DENSO **5DN12**

A: -
B: -
C: -
21MM

DENSO **5DN13**

A: 105 mm
B: 39 mm
C: 19,4 mm

7SB/7SBU/6CA17
10PA/11/13/15/17/20

DENSO **5DN14**

A: 135 mm
B: 34,5 mm
C: 18 mm

6SEU12C

DENSO **5DN15**

A: -
B: -
C: -
23 MM

DENSO **5DN16**

A: -
B: -
C: -
48 MM

DENSO **5DN17**

A: 93,5 mm
B: 24,9 mm
C: 16,8 mm

SCSA06,
SCSB06

DENSO **5DN18**

A: 93,5 mm
B: 23,2 mm
C: 15,7 mm

SCSA06 /
SCSB06

DENSO **5DN19**

A: 94 mm
B: 38 mm
C: -

6SE

DENSO **5DN20**

A: 102 mm
B: 32 mm
C: 16,5 mm

10S

DENSO **5DN21**

A: 88 mm
B: 20,3 mm
C: 12,2 mm

SCSA06,
SCSB06

DENSO **5DN22**

A: 94 mm
B: 21,7 mm
C: 13,9 mm

SCSA06,
SCSB06

DENSO **5DN23**

A: -
B: -
C: -

10SEU17C

DENSO **5DN24**

A: -
B: -
C: -

10SEU17C

DENSO **5DN25**

A: 102 mm
B: 30 mm
C: 12 mm

6SEU16C/
6SBU16C

DENSO **5DN27**

A: 84 mm
B: 27,5 mm
C: 18 mm

6SEU16C/
6SBU16C

DENSO **5DN28**

A: 96 mm
B: 37 mm
C: -

5TSE10C

DENSO **5DN29**



A: 98 mm
B: 23,7 mm
C: 12,5 mm

 6SAS14C

AUDI

DENSO **5DN30**



A: 110 mm
B: 37 mm
C: -

 5TSE10C

TOYOTA

DENSO **5DN31**



A: 98 mm
B: 24 mm
C: 12,5 mm

 6SB/7SB

DENSO **5DN32**



A: 104 mm
B: 35,5 mm
C: -

 5SE09

TOYOTA

DENSO **5DN33**



A: -
B: -
C: -

 6SEU, 5SL, 5SE

BMW/TOYOTA

DENSO **5DN35**



A: 89 mm
B: 33,5 mm
C: -

 5SL12C

FIAT/ OPEL

DENSO **5DN36**



A: -
B: -
C: -

VW T5

DENSO **5DN37**



A: -
B: -
C: -

VW T5

DENSO **5DN38**



A: 128 mm
B: 45 mm
C: 25,5 mm

 6E171

JOHN DEERE

DENSO **5DN39** *NEW!!! v.01*



A: 97,7 mm
B: 32,4 mm
C: 13,2 mm

FORD FS

FORD FS **5FS01**



A: 122 mm
B: 31 mm
C: 15,7 mm

 FS

FORD

FORD FS **5FS02**



A: 122 mm
B: 31 mm
C: 21,3 mm

 FS10

FORD

FORD FS **5FS03**



A: 122 mm
B: 28 mm
C: 17 mm

 FS

FORD

FORD FS **5FS04**



A: 122 mm
B: 39 mm
C: 20 mm

 FS10

FORD

HALLA **5HA01**



A: 105 mm
B: 34,8 mm
C: 15,4 mm

 HS18

HYUNDAI/KIA

HALLA **5HA02**



A: 109,5 mm
B: 37 mm
C: 20 mm

HYUNDAI/KIA

HALLA **5HA03**



A: 105 mm
B: 37 mm
C: 21,5 mm

 VS16

HYUNDAI

HALLA **5HA04**



A: 110 mm
B: 38 mm
C: 21 mm

 VS16

HYUNDAI

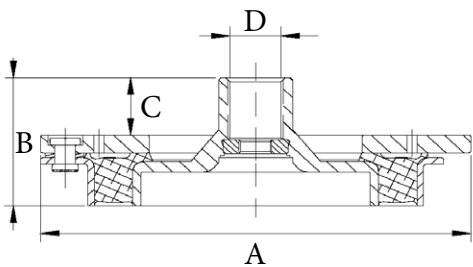

HALLA **5HA05**

A: -
B: -
C: -

HYUNDAI/KIA

HALLA **5HA06**

A: -
B: -
C: -

HYUNDAI/KIA

HALLA **5HA07**

A: 98,5 mm
B: 24,5 mm
C: 14 mm

HYUNDAI

HALLA **5HA08**

A: 100 mm
B: 34 mm
C: 16,6 mm

HYUNDAI/ KIA

HALLA **5HA09**

A: 109 mm
B: 38,9 mm
C: 18,8 mm

FORD HS-15

HALLA **5HA10**

A: 92,5 mm
B: 27,5 mm
C: 3,2 mm

HYUNDAI/KIA DVE-16

HALLA **5HA11**

A: 105 mm
B: 39,5 mm
C: 19,3 mm

HYUNDAI HS-20

HALLA **5HA12**

A: 90 mm
B: 13 mm
C: -

HYUNDAI/KIA

HALLA **5HA13**

A: 99 mm
B: 22,5 mm
C: 6,5 mm

HYUNDAI/KIA

HALLA **5HA14**

A: 100,5 mm
B: 30,4 mm
C: -

HYUNDAI/KIA HCC

HALLA **5HA15**

A: 111,5 mm
B: 38 mm
C: 20,8 mm

HYUNDAI/KIA HS-15

HALLA **5HA16**

A: -
B: -
C: -

HYUNDAI/KIA VS-18E

KEIHIN **5KE01**

A: 102 mm
B: 20 mm
C: 6,1 mm

HONDA HS-110R

MITSUBISHI **5MI01**

A: 94 mm
B: 14 mm
C: 1,6 mm

MITSUBISHI MSC060

MITSUBISHI **5MI02**

A: 102 mm
B: 25,3 mm
C: 8,4 mm

MITSUBISHI MSC

MITSUBISHI **5MI03**

A: 92 mm
B: 11,5 mm
C: 2,8 mm

MITSUBISHI QS90

MITSUBISHI **5MI04**

A: 92 mm
B: 14 mm
C: 3 mm

MITSUBISHI

PANASONIC **5PA01**

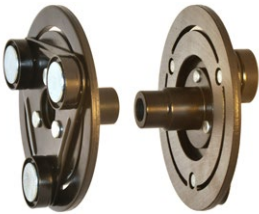

A: 109,5 mm
B: 47 mm
C: 30,2 mm

MAZDA

PANASONIC **5PA02**



A: 102 mm
B: 47 mm
C: 30,2 mm

MAZDA

PANASONIC **5PA03**

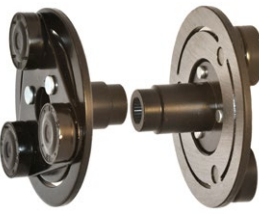

A: 95 mm
B: 50 mm
C: 34 mm

MAZDA

PANASONIC **5PA04**



A: 109,5 mm
B: 35,5 mm
C: 18,5 mm

MAZDA

PANASONIC **5PA05**



A: 104,3 mm
B: 27 mm
C: 10,3 mm

MAZDA

PANASONIC **5PA06**



A: 110 mm
B: 27 mm
C: 10 mm

MAZDA

PANASONIC **5PA07**



A: 95 mm
B: 23,5 mm
C: 10,8 mm

SUZUKI

PANASONIC **5PA08** NEW!!!
v. 01



A: 110 mm
B: 55,5 mm
C: 38,7 mm

NISSAN  CR-12S

SCROLL **5SC01**



A: 107,4 mm
B: 18 mm
C: 5 mm

FORD  SCROLL

SANDEN **5SD01**



A: 106 mm
B: 28 mm
C: 5,5 mm

AUDI/SEAT/SKODA/VW  PXE13/
PXE16

SANDEN **5SD02**



A: 91 mm
B: 26 mm
C: 16 mm

AUDI/SEAT/SKODA/VW  PXE14/
PXE16

SANDEN **5SD03**



A: 105 mm
B: 27,7 mm
C: 10 mm

OPEL  PXE16

SANDEN **5SD04**



A: 105 mm
B: 28 mm
C: 14 mm

AUDI/SEAT/SKODA/VW  SD6V12/
SD7V16/
SD7H15

SANDEN **5SD05**



A: 105 mm
B: 27 mm
C: 14 mm

AUDI/SEAT/SKODA/VW  SD7V16

SANDEN **5SD06**



A: 105 mm
B: 30,2 mm
C: 13 mm

OPEL  SD7V16

SANDEN **5SD07**



A: 90 mm
B: 21 mm
C: 11,5 mm

OPEL  PXE16

SANDEN **5SD08**



A: 90,5 mm
B: 26 mm
C: 16,2 mm

OPEL  PXE

SANDEN **5SD09**



A: 110,5 mm
B: 32,2 mm
C: 15 mm

VOLVO FH

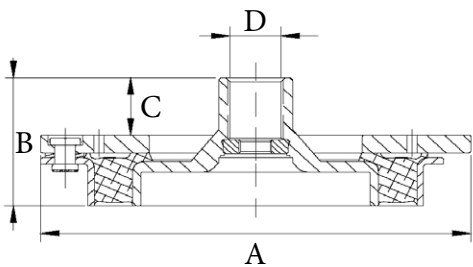

SANDEN **5SD10**

A: 105 mm
B: 32 mm
C: 14,8 mm

PX

OPEL/SAAB

SANDEN **5SD11**

A: 106 mm
B: 22,1 mm
C: 12,9 mm

SD7H15/
SD7V16/
SD6V12

SANDEN **5SD12**

A: 105 mm
B: 17 mm
C: 4,4 mm

TRS

HONDA

SANDEN **5SD13**

A: 105 mm
B: 18,8 mm
C: 6 mm

TRS

HONDA

SANDEN **5SD14**

A: 105 mm
B: 18 mm
C: 8,9 mm

SD7C16

CITROEN/PEUGEOT

SANDEN **5SD15**

A: 105 mm
B: 22,7 mm
C: 10,3 mm

PXC16

FORD/OPEL

SANDEN **5SD17**

A: 105 mm
B: 28 mm
C: 17,8 mm

SD6V12

SEAT/ VW

SANDEN **5SD18**

A: 105 mm
B: 20 mm
C: 10 mm

SD7H15

CHRYSLER/JEEP

SANDEN **5SD19**

A: 102 mm
B: 31 mm
C: 13,5 mm

PXC14

MERCEDES

SANDEN **5SD20**

A: 105 mm
B: 22 mm
C: 9 mm

SD7V16

OPEL/SAAB

SANDEN **5SD21**

A: 105,1 mm
B: 25,7 mm
C: 8,5 mm

PXV

OPEL

SANDEN **5SD22**

A: 119,5 mm
B: 26,6 mm
C: 14 mm

SD5H14/
SD5H15

SPEC.VEH.

SANDEN **5SD23**

A: 112 mm
B: 26,4 mm
C: 13,6 mm

SD7H15

SPEC.VEH.

SANDEN **5SD24**

A: 105 mm
B: 30,3 mm
C: 16,3 mm

FORD

SANDEN **5SD25**

A: 109 mm
B: 15 mm
C: 2 mm

HS110R/
TRSE07

HONDA

SANDEN **5SD26**

A: 92 mm
B: 16,2 mm
C: 3,3 mm

TRSE09/
TRSA09

HONDA

SANDEN **5SD28**

A: 105 mm
B: 20 mm
C: 8,3 mm

SANDEN **5SD29**

A: 102,3 mm
B: 23,3 mm
C: 12 mm

 TRS

HONDA

SANDEN **5SD30**

A: 109,2 mm
B: 23 mm
C: 9,5 mm



SPEC.VEH.

SANDEN **5SD31**

A: 110 mm
B: 26,5 mm
C: 14 mm

 SD7H13/
SD7H14

SPEC.VEH.

SANDEN **5SD32**

A: 102 mm
B: 25,2 mm
C: 12,6 mm

 PXC

VOLVO

SANDEN **NEW!!!** **5SD33**
v.01

A: 110 mm
B: 26,5 mm
C: 14 mm

 SD7H15

SPEC.VEH.

SEIKO-SEIKI **5SS01**

A: 103,7 mm
B: 32,8 mm
C: 19 mm

 S120DL1

BMW

SEIKO-SEIKI **5SS02**

A: 109 mm
B: 41 mm
C: 24 mm



BMW

SEIKO-SEIKI **5SS03**

A: 92 mm
B: 23 mm
C: 12 mm



SUZUKI/SMART

SEIKO-SEIKI **5SS04**

A: 92,2 mm
B: 26,7 mm
C: 15,5 mm



CITROEN/PEUGEOT

UNICLA **NEW!!!** **5UN01**
v.01

A: 120 mm
B: 36 mm
C: 24 mm

 UP200/
UX200

SPEC.VEH.

UNICLA **NEW!!!** **5UN02**
v.01

A: 150 mm
B: 43 mm
C: 29,5 mm

 UX310/
UX330

SPEC.VEH.

VISTEON **5VI01**

A: 116 mm
B: 38,2 mm
C: 21 mm

 VS

FORD/VOLVO

VISTEON **5VI02**

A: 115 mm
B: 36,9 mm
C: 20 mm

 VS16

FORD

VISTEON **5VI03**

A: 110 mm
B: 40 mm
C: 21 mm

 VS

VISTEON **5VI04**

A: 115 mm
B: 41 mm
C: 23 mm

 VS-16

FORD

VISTEON **5VI05**

A: 87 mm
B: 25,5 mm
C: 13,9 mm

 CMP01

BMW

VISTEON **5VI06**

A: 115 mm
B: 40 mm
C: 21,3 mm



FORD

VISTEON **5VI07**

A: 115 mm
B: 32 mm
C: 22 mm



FORD

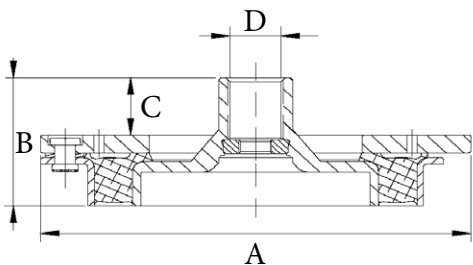

VISTEON **5VI08**

A: 108 mm
B: 17,6 mm
C: 9,1 mm

VS

FORD

VISTEON **5VI09** NEW!!! v.01

A: 115 mm
B: 37 mm
C: 20 mm

VS-16

FORD

YORK **5YO01**

A: 134 mm
B: 45 mm
C: 34 mm

ER210R

VW

ZEXEL **5ZX01**

A: 92 mm
B: 22,5 mm
C: -

DCS17E

VW

ZEXEL **5ZX02**

A: 85,5 mm
B: 22 mm
C: 4 mm

DCS17/ KC88

MERCEDES

ZEXEL **5ZX03**

A: 112,2 mm
B: 32,5 mm
C: 16 mm

TM 16/15/ 13/11/08

VOLVO

ZEXEL **5ZX04**

A: 112 mm
B: 22 mm
C: 9 mm

KC 88/DKS

VOLVO

ZEXEL **5ZX05**

A: 112,2 mm
B: 32,5 mm
C: 16 mm

DKS17D

VOLVO

ZEXEL **5ZX06**

A: 111 mm
B: 36,4 mm
C: 24 mm

NISSAN/OPEL/RENAULT

ZEXEL **5ZX07**

A: 110 mm
B: 18 mm
C: 6,5 mm

KC 88/ DCS17

NISSAN/OPEL/RENAULT

ZEXEL **5ZX08**

A: 92 mm
B: 22,5 mm
C: 11,5 mm

DKV08R

NISSAN

ZEXEL **5ZX09**

A: 100 mm
B: 21 mm
C: 12,3 mm

DKV-10R

SUBARU

ZEXEL **5ZX10**

A: 140 mm
B: 41,4 mm
C: 24 mm

DKS320

MITSUBISHI/TOYOTA

ZEXEL **5ZX11**

A: 92 mm
B: 21 mm
C: 12 mm

DKV-08R

SUZUKI

ZEXEL **5ZX12**

A: 95 mm
B: 25 mm
C: 12,2 mm

DKV-10R

SUBARU

ZEXEL **5ZX13**

A: 105,3 mm
B: 25 mm
C: 7,9 mm

DCS17IC

ALFA ROMEO/FIAT/ LANCIA

ZEXEL **5ZX14**

A: 150 mm
B: 43 mm
C: 27 mm

TM43

ALFA ROMEO/FIAT/ LANCIA

ZEXEL **5ZX15**

A: 185 mm
B: 58 mm
C: 35 mm

 TM65



ZEXEL **5ZX16**

A: 110 mm
B: 25,5 mm
C: 12 mm

 DCW17



AUDI/VW

ZEXEL **5ZX17**

A: 111,8 mm
B: 27,6 mm
C: 14,2 mm

 DCS-141C



SUZUKI

ZEXEL **5ZX18**

A: 111,5 mm
B: 22,8 mm
C: 10 mm

 DCS-17EC



RENAULT

ZEXEL **5ZX19**

A: 111,8 mm
B: 39 mm
C: 27,8 mm

 DKS15D



MITSUBISHI

ZEXEL **5ZX20**

A: 109 mm
B: 37,3 mm
C: 17,6 mm

 DKS17D



NISSAN

ZEXEL **5ZX21**

A: 111,5 mm
B: 27,5 mm
C: 15,7 mm



SUBARU

ZEXEL **5ZX22**

A: 112 mm
B: 49 mm
C: 37 mm



VOLVO

ZEXEL **5ZX23**

A: 111 mm
B: 38 mm
C: 25,8 mm

 DCW
15CH/17CH



VOLVO

ZEXEL **5ZX24**

A: 92 mm
B: 38 mm
C: 30 mm

 DKV-08



SUBARU/SUZUKI

	A	B	C	D
5CL01	109,5	32,7	15,7	12,5x23x0,5
5CL02	115	21,2	11,2	13,5x25x0,5
5CL03	110	19	10	13,5x25
5CL04	110	16,5	6	13x25
5CL05	90	21	13	11x
5CL06	115	21	10	13,5x25x0,5
5CL07	104,1	22,5	12	12,5x23
5CL08	105,2	43	30,6	12,1x23
5CL09	110,8	37,5	20	13,4x26x0,5
5DL01	90	19,5	9,5	12,5x23x0,5
5DL02	105	26	13,3	12,5x23x0,5
5DL03	90	19,5	10	12,5x23x0,5
5DL04	110	23	10,2	-
5DL05	86	25	15	12,5x24x0,5
5DL06	128	32	23,2	13,7
5DL07	120	34	23,2	13,7
5DL08	111	34	23,2	13,7
5DL09	108	21	10	12,5x24x0,5
5DL10	105	28	12,2	-
5DL11	75	19	-	-
5DL12	92	11	2,2	-
5DL13	118	51	28,5	13,9
5DL14	105	24	13,4	12,5x23x0,5
5DL15	117,5	62,5	41,2	13,8
5DL16	105	29	10	12x24x0,5
5DN03	83	19,6	-	M10 x 1,25
5DN04	74,5	22,3	-	13,5x25x0,5
5DN06	74,5	22,3	-	13,5x25x0,5
5DN07	83	19,2	-	M10 x 1,25
5DN09	84	30	-	8,9
5DN10	85,5	29	-	8,9
5DN11	83	31,6	-	M10 x 1,25
5DN13	105	39	19,4	13,5x25x0,5
5DN14	135	34,5	18	M10 x 1,25
5DN17	93,5	24,9	16,8	13,5x25x0,5
5DN18	93,5	23,2	15,7	M10 x 1,25
5DN19	94	38	-	8,9
5DN20	102	32	16,5	13,5x25
5DN21	88	20,3	12,2	13,5x25
5DN22	94	21,7	13,9	13,5x25
5DN25	102	30	12	M10 x 1,25
5DN27	84	27,5	18	-
5DN28	96	37	-	M10 x 1,25
5DN29	98	23,7	12,5	M10 x 1,25
5DN30	110	37	-	M10 x 1,25
5DN31	98	24	12,5	13,5x25x0,5
5DN32	104	35,5	-	M10 x 1,25
5DN35	89	33,5	-	M10 x 1,25
5DN38	128	45	25,5	13,5
5DN39	97,7	32,4	13,2	13,5x25x0,5
5FS01	122	31	15,7	13,6x21x0,6

CLUTCH HUBS

Tarcze sprzęgła - tabela

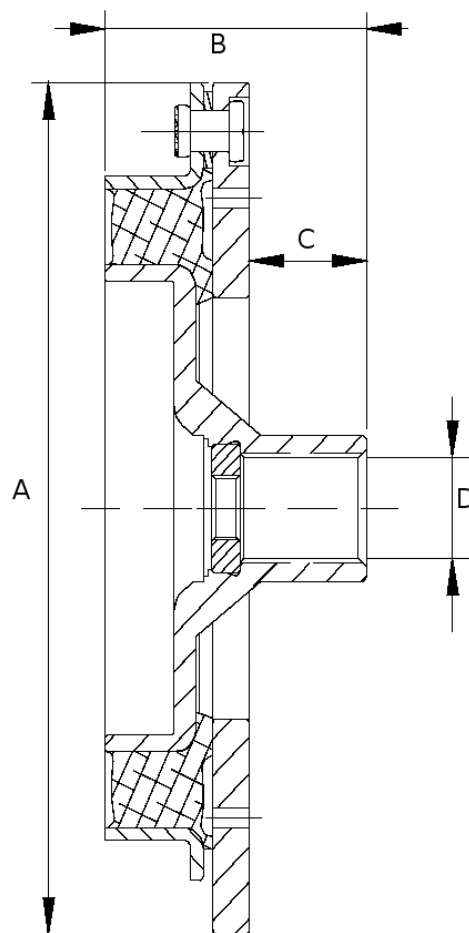

- A- magnetic slot (Średnica całkowita)
- B- height (Wysokość całkowita)
- C- face height (Wysokość mocowania)
- D- assembly (Rodzaj mocowania)

	A	B	C	D
5FS02	122	31	21,3	13,6x21x0,6
5FS03	122	28	17	13,6x21x0,6
5FS04	122	39	20	13,6x21x0,6
5HA01	105	34,8	15,4	13,6x21x0,6
5HA02	109,5	37	20	13,6x21x0,6
5HA03	105	37	21,5	13,6x21x0,6
5HA04	110	38	21	13,6x21x0,6
5HA07	98,5	24,5	14	13,6x21x0,6
5HA08	100	34	16,6	13,6x21x0,6
5HA09	109	38,9	18,8	13,2x21x0,5
5HA10	92,5	27,5	3,2	13,6x25
5HA11	105	39,5	19,3	13,6x21
5HA12	90	13	-	50
5HA13	99	22,5	6,5	13,2x21x0,6
5HA14	100,5	30,4	-	M9 x 1,25
5HA15	111,5	38	20,8	13x21x0,5
5KE01	102	20	6,1	9,5x18x0,5
5MI01	94	14	1,6	9,5x18x0,5
5MI02	102	25,3	8,4	17 (-1)x9,6
5MI03	92	11,5	2,8	17x9,5
5MI04	92	14	3	18x9,5
5PA01	109,5	47	30,2	12,5x23x0,5
5PA02	102	47	30,2	12,5x23x0,5
5PA03	95	50	34	12,5x23x0,5
5PA04	109,5	35,5	18,5	13,5x25
5PA05	104,3	27	10,3	-
5PA06	110	27	10	12,5x23x0,5
5PA07	95	23,5	10,8	12,5x23x0,5
5PA08	110	55,5	38,7	12,5x23x0,5
5SC01	107,4	18	5	17 (-1) 9,55
5SD01	106	28	5,5	13x24x0,5
5SD02	91	26	16	13x24x0,5
5SD03	105	27,7	10	11,5x22x0,5
5SD04	105	28	14	11,5x22x0,5
5SD05	105	27	14	11,5x22x0,5
5SD06	105	30,2	13	11,5x22x0,5
5SD07	90	21	11,5	12,51x23
5SD08	90,5	26	16,2	13x24x0,5
5SD09	110,5	32,2	15	12,9
5SD10	105	32	14,8	13x24
5SD11	106	22,1	12,9	12,9
5SD12	105	17	4,4	9,5x18
5SD13	105	18,8	6	9,5x18
5SD14	105	18	8,9	11,50x22
5SD15	105	22,7	10,3	13,2X24
5SD17	105	28	17,8	11,5x22x0,5
5SD18	105	20	10	13x23(-1)x0,5
5SD19	102	31	13,5	11,5x22x0,5
5SD20	105	22	9	11x21(-1)
5SD21	105,1	25,7	8,5	13,1
5SD22	119,5	26,6	14	13,1x24

CLUTCH HUBS

Tarcze sprzęgła - tabela

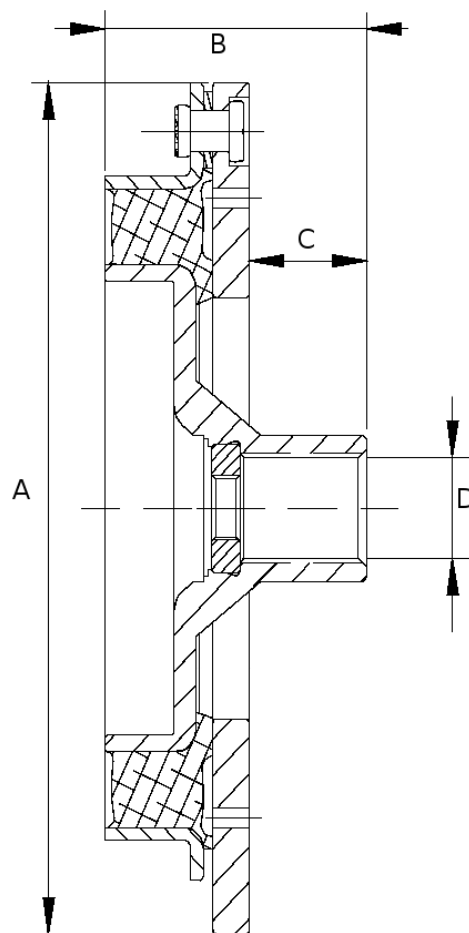

- A- magnetic slot (Średnica całkowita)
- B- height (Wysokość całkowita)
- C- face height (Wysokość mocowania)
- D- assembly (Rodzaj mocowania)

	A	B	C	D
5SD23	112	26,4	13,6	12,8
5SD24	105	30,3	16,3	11,2x21(-1)
5SD25	109	15	2	9,6x17(-1)
5SD26	92	16,2	3,3	9,6x18
5SD28	105	20	8,3	11,3x22x0,5
5SD29	102,3	23,3	12	9,5x17(-1)
5SD30	109,2	23	9,5	12,8
5SD31	110	26,5	14	12,8
5SD32	102	25,2	12,6	13x24x0,5
5SD33	110	26,5	14	13
5SS01	103,7	32,8	19	12,5x23
5SS02	109	41	24	12x23
5SS03	92	23	12	12x23
5SS04	92,2	26,7	15,5	12,4x23
5UN01	120	36	24	13,5x25x0,5
5UN02	150	43	29,5	19,5
5VI01	116	38,2	21	13,5x21x0,5
5VI02	115	36,9	20	13,5x21x0,5
5VI03	110	40	21	13,5x21x0,5
5VI04	115	41	23	13,5x21x0,5
5VI05	87	25,5	13,9	13x24x0,5
5VI06	115	40	21,3	13,5x21x0,5
5VI07	115	32	22	13,6x21
5VI08	108	17,6	9,1	12,5x24x0,5
5VI09	115	37	20	13,3x21x0,5
5YO01	134	45	34	21
5ZX01	92	22,5	-	13,5x26x0,5
5ZX02	85,5	22	4	13,5x26x0,5
5ZX03	112,2	32,5	16	13,5x25x0,5
5ZX04	112	22	9	13,5x26x0,5
5ZX05	112,2	32,5	16	13,5x25x0,5
5ZX06	111	36,4	24	13,5x26x0,5
5ZX06	110	18	6,3	13,5x26x0,5
5ZX07	110	18	6,5	13,5x36x0,5
5ZX08	92	22,5	11,5	12,5x23x0,5
5ZX09	100	21	12,3	-
5ZX10	140	41,4	24	17x33x0,5
5ZX11	92	21	12	12,5x23x0,5
5ZX12	95	25	12,2	12,5x23x0,5
5ZX13	105,3	25	7,9	13,5x26x0,5
5ZX14	150	43	27	20x38x0,5
5ZX15	185	58	35	24x30x0,5
5ZX16	110	25,5	12	13,5x25
5ZX17	111,8	27,6	14,2	13,8x26
5ZX18	111,5	22,8	10	13,8x26
5ZX19	111,8	39	27,8	13,4x25
5ZX20	109	37,3	17,6	13,5x25
5ZX21	111,5	27,5	15,7	13,7x26
5ZX22	112	49	37	13,3x25x0,5
5ZX23	111	38	25,8	13,3x25x0,5
5ZX24	92	38	30	12x23x0,5

CLUTCH HUBS

Tarcze sprzęgła - tabela

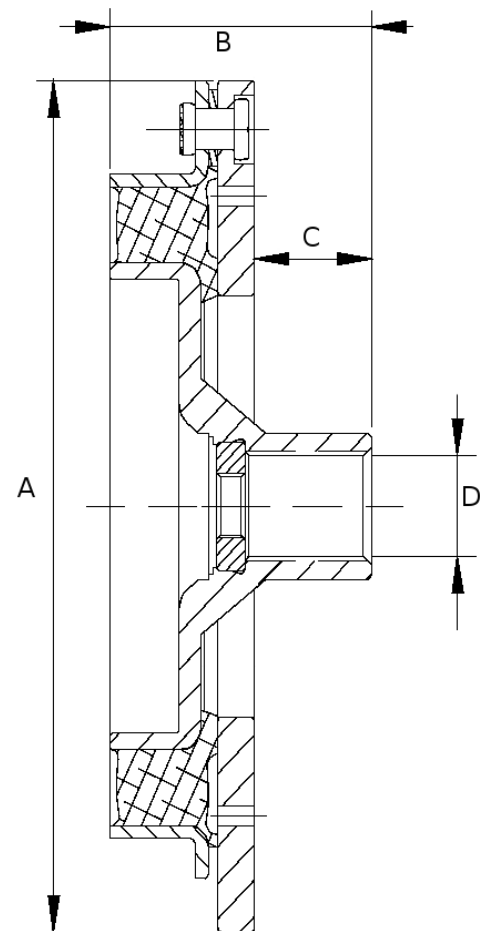

- A- magnetic slot (Średnica całkowita)
- B- height (Wysokość całkowita)
- C- face height (Wysokość mocowania)
- D- assembly (Rodzaj mocowania)

CALSONIC **6CL01**



Ø 110/110mm
 12V
 CVC/
 CSV717

BMW

35x52x20 4CL01 5CL01

CALSONIC **6CL02**



Ø 129/124mm
 12V
 CWV615M

NISSAN

35x55x20 4CL02 5CL04

CALSONIC **6CL03**



Ø 129/124mm
 12V
 CWV615M

NISSAN

35x55x20 4CL03 5CL03

CALSONIC **6CL04**



Ø 119/115mm
 12V

NISSAN

35x55x20 4CL02 5ZX07

CALSONIC **6CL05**



Ø 109/109mm
 12V
 CSE717

BMW

35x50x20 n/a 5CL05

CALSONIC **6CL06**



Ø 139/135mm
 12V

NISSAN

35x55x20 4CL03 5CL02

CALSONIC **6CL07**



Ø 119/114mm
 12V
 CSV617

NISSAN

35x50x20 4CL08 5CL07

CALSONIC **6CL08**



Ø 129/125mm
 12V
 CR-12SC

RENAULT

35x55x20 4CL10 5CL08

CALSONIC **6CL09**



Ø 114/110mm
 12V
 CR10

NISSAN

35x55x20

CALSONIC **6CL10**



Ø 110/110mm
 12V
 CSE717

BMW

35x55x20 4CL01 5CL01

CALSONIC **6CL11**



Ø 110/110mm
 12V
 CSE717

BMW

35x55x22 4CL01 5CL01

CALSONIC **6CL12**



Ø 110/110mm
 12V
 CWV717/
 CSE717

BMW

35x55x20 4CL01 5CL01

CALSONIC **6CL13**



Ø 119/114mm
 12V
 CR-12S

NISSAN

35x55x20

CALSONIC **6CL14**



Ø 104/100mm
 12V
 CR08

NISSAN

30x47x18 4ZX10

CALSONIC **6CL15**



Ø 115/110mm
 12V
 CSE613C

BMW

35x52x20 n/a 5CL05

CALSONIC **6CL16**



Ø 139/135mm
 12V
 SS10LV8
 CR10

NISSAN

35x55x20

CALSONIC **6CL17**



Ø 104/100mm
 12V

NISSAN

30x47x18

CALSONIC **6CL18** NEW!!! v.01



Ø 104/100mm
 12V
 CR-10

NISSAN

35x55x20

CALSONIC *NEW!!! v.01* **6CL19**



Ø 110/110mm
 1V5
 12V
 CSV613

BMW

35x55x20

CALSONIC *NEW!!! v.01* **6CL20**



Ø 110/110mm
 1V6
 12V
 CSV613

BMW

35x55x20

CALSONIC *NEW!!! v.01* **6CL21**



Ø 132/128mm
 1V4
 12V

BMW

35x55x20

DELPHI **6DL01**



Ø 109/105mm
 1V6
 12V
 CVC

OPEL

35x50x20 4DL01 5DL02

DELPHI **6DL02**



Ø 129/125mm
 1V6
 12V
 CVC

RENAULT/NISSAN

35x55x20 4DL05 5DL04

DELPHI **6DL03**



Ø 109/105mm
 1V5
 12V
 CVC

OPEL

35x52x20 n/a 5DL01

DELPHI **6DL04**



Ø 109/105mm
 1V6
 12V
 CVC

OPEL

35x52x20 n/a 5DL01

DELPHI **6DL05**



Ø 134/128mm
 1V6
 12V
 V5

OPEL

40x62x20,6 4DL02 5DL07

DELPHI **6DL06**



Ø 124/119mm
 1V6
 12V
 V5

OPEL

40x62x20,6 4DL02 5DL07

DELPHI **6DL07**



Ø 115/110mm
 1V6
 12V
 DH5

AUDI/SEAT/SKODA/VW

35x55x20 n/a 5DL03

DELPHI **6DL08**



Ø 122/118mm
 1V7
 12V
 CVC

RENAULT/NISSAN

35x55x20 4DL05 5DL04

DELPHI **6DL09**



Ø 129/125mm
 1V6
 12V
 V5

OPEL

40x62x20 4DL02 5DL08

DELPHI **6DL10**



Ø 125/121mm
 1V6
 12V
 SP17

CHEVROLET

35x52x22 4DL10 5DL09

DELPHI **6DL11**



Ø 126/122mm
 1V6
 12V
 10S

CHEVROLET

30x52x22 4DN01 5DN13

DELPHI **6DL12**



Ø 126/122mm
 1V6
 12V

CHEVROLET

35x52x22 5DN13

DELPHI **6DL13**



Ø 103/94mm
 1V6
 12V
 GM QS90

OPEL

32x47x18 4DL12 5DL12

DELPHI **6DL14**



Ø 123/119mm
 1V7
 12V
 V5

RENAULT

40x62x20,6 4DL03 5DL07

DELPHI **6DL15**



Ø 109/104mm
 1V5
 12V
 CVC

OPEL

35x50x20 4DL01 5DL02

DELPHI **6DL16**



Ø 114/110mm
 V5
 12V
 CVC/
 GM0274

OPEL/CHEVROLET

35x52x20 4DL11 5DL10

DELPHI **6DL17**



Ø 124/119mm
 V6
 12V
 HD6/DA6

BUICK/RENAULT

40x62x20,6 4DL03 5DL07

DELPHI **6DL18**



Ø 113/110mm
 V6
 12V
 DH5

AUDI/SEAT/SKODA/VW

35x55x20 n/a 5DL11

DELPHI **6DL19**



Ø 114/110mm
 V6
 12V

OPEL/CHEVROLET

35x52x20 4DL11 5DL10

DELPHI **6DL20**



Ø 109/105mm
 V6
 12V
 CVC

OPEL

35x50x20 4DL01 5DL14

DELPHI **6DL21**



Ø 132mm
 2A
 24V
 V5

SPEC. VEH.

40x62x20,6 4DL20 5DL07

DELPHI **6DL22**



Ø 125/121mm
 V6
 12V
 V5

RENAULT

40x62x20,6 4DL03 5DL07

DELPHI **6DL23**



Ø 114/110mm
 V6
 12V

HONDA

35x50x20

DELPHI **6DL24**



Ø 115/110mm
 V7
 12V

HONDA

35x50x20

DELPHI **6DL25**



Ø 125/120mm
 V6
 12V

CHEVROLET

35x52x22

DELPHI **6DL26**



Ø 111/107mm
 V4
 12V
 SP-10

CHEVROLET

35x52x20

DELPHI **6DL27**



Ø 114/110mm
 V6
 12V
 CVC

OPEL

35x55x20 n/a 5DL05

DELPHI **6DL28**



Ø 114/110mm
 V6
 12V
 CVC

ALFA ROMEO, FIAT

35x50x20 4DL17

DELPHI **6DL29**



Ø 125/119mm
 V6
 12V
 CVC

MASERATI

35x52x22 4DL16

DELPHI **NEW!!! v.01** **6DL30**



Ø 110/106mm
 V6
 12V
 CVC

MINI

35x50x20

DELPHI **NEW!!! v.01** **6DL31**



Ø 129/125mm
 V6
 12V

MASERATI

35x52x22

DELPHI **NEW!!! v.01** **6DL32**



Ø 114/110mm
 V5
 12V

FIAT

35x50x20

DENSO **6DN01**



Ø 114/109mm
 V4
 12V
 6SE/7SE

AUDI

35x52x22 n/a 5DN04 5DN01

DENSO **6DN02**

 Ø 119mm
 12V
 7SEU17C
VW
 35x52x22 n/a 5DN04 5DN01

DENSO **6DN03**

 Ø 126/120mm
 12V
 7SBU16C
AUDI/SEAT/SKODA/VW
 35x52x22 4DN02 5DN13

DENSO **6DN04**

 Ø 116/110mm
 12V
 6SEU12C
MERCEDES
 35x52x22 n/a 5DN06 5DN05

DENSO **6DN05**

 Ø 105/100mm
 12V
 7SEU17C
AUDI/MERCEDES
 35x52x12 n/a 5DN03 5DN02

DENSO **6DN06**

 Ø 105/100mm
 12V
 5SE12C/6SE/7SE
MERCEDES
 35x52x12 n/a 5DN03 5DN02

DENSO **6DN07**

 Ø 105/100mm
 12V
 5SE/6SE
TOYOTA
 35x52x12 n/a 5DN11 5DN02

DENSO **6DN08**

 Ø 125/120mm
 12V
 5SEU12C/6SEU14C
TOYOTA
 35x52x12 n/a 5DN11 5DN02

DENSO **6DN09**

 Ø 120/115mm
 12V
 5SE09
TOYOTA
 35x52x12 n/a 5DN07 5DN08

DENSO **6DN10**

 Ø 116/110mm
 12V
 7SEU16C
MERCEDES
 35x52x22 n/a 5DN04 5DN01

DENSO **6DN11**

 Ø 100/100mm
 12V
 7SEU17C
BMW
 35x52x12 n/a 5DN03 5DN02

DENSO **6DN12**

 Ø 115/110mm
 12V
 6SE/7SE
AUDI
 35x52x22 n/a 5DN03 5DN02

DENSO **6DN13**

 Ø 105/100mm
 12V
 6SE/7SE
AUDI
 35x52x22 n/a 5DN03 5DN02

DENSO **6DN14**

 Ø 110/110mm
 12V
 6SEU12C
AUDI
 35x52x22 n/a 5DN04 5DN01

DENSO **6DN15**

 Ø 105/100mm
 12V
 6SEU14C
AUDI/VW
 35x52x20 n/a 5DN09

DENSO **6DN16**

 Ø 105/100mm
 12V
 6SE/7SE
MERCEDES
 35x52x20 n/a 5DN10

DENSO **6DN17**

 Ø 125mm
 12V
TOYOTA
 35x52x12 n/a 5DN11 5DN02

DENSO **6DN18**

 Ø 130mm
 12V
MERCEDES
 35x52x22 n/a 5DN03 5DN02

DENSO **6DN19**

 Ø 115/110mm
 12V
 5SE12C/5SL12C
OPEL/FIAT
 35x52x22 n/a 5DN03 5DN02

DENSO **6DN20**

 Ø 124/120mm
 V7
 12V
 6SEU14C
MERCEDES
 35x52x22 n/a 5DN03
 5DN02

DENSO **6DN21**

 Ø 105/100mm
 V6
 12V
 5SE09C
TOYOTA
 35x52x12 n/a 5DN11
 5DN02

DENSO **6DN22**

 Ø 115/109mm
 V4
 12V
 10PA17C/
 10S17C
IVECO
 30x52x22 4DN01 5DN13

DENSO **6DN23**

 Ø 135/130mm
 V7
 12V
 10S17C
HONDA
 30x52x22 4DN05 5DN20

DENSO **6DN24**

 Ø 115/110mm
 V7
 12V
 5SE12C
TOYOTA
 35x52x12 n/a 5DN11
 5DN02

DENSO **6DN25**

 Ø 115/110mm
 V5
 12V
 5SE12
FIAT/GM/OPEL
 35x52x22 n/a 5DN11
 5DN02

DENSO **6DN26**

 Ø 115/110mm
 V5
 12V
 6SEU16
MERCEDES
 35x52x12 n/a 5DN03
 5DN02

DENSO **6DN27**

 Ø 110/110mm
 V6
 12V
 7SEU17C
BMW
 35x52x12 n/a 5DN07
 5DN33

DENSO **6DN28**

 Ø 130/125mm
 V6
 12V
 6SE/7SEU/
 6SEL14C
RENAULT/PSA
 35x52x20 n/a 5DN03
 5DN02

DENSO **6DN29**

 Ø 110/110mm
 V7
 12V
 6SEU14C
BMW
 35x52x12 n/a 5DN07
 5DN33

DENSO **6DN30**

 Ø 115/110mm
 V6
 12V
 6SE/7SE
MERCEDES
 35x52x12 n/a 5DN03
 5DN02

DENSO **6DN31**

 Ø 125/120mm
 V6
 12V
 5SE/6SEU
TOYOTA
 35x52x12 n/a 5DN11
 5DN02

DENSO **6DN32**

 Ø 115/110mm
 V6
 12V
 6SEU12C
VW
 35x52x20 n/a 5DN03
 5DN02

DENSO **6DN33**

 Ø 115/110mm
 V6
 12V
 5SL12C
OPEL
 35x52x22 n/a 5DN04
 5DN01

DENSO **6DN34**

 Ø 125/121mm
 V4
 12V
 5SE/6SE
TOYOTA
 35x52x12 n/a 5DN03
 5DN02

DENSO **6DN35**

 Ø 132/110mm
 V7
 12V
 6SEU16C
TOYOTA
 35x52x12 n/a 5DN14

DENSO **6DN36**

 Ø 125/119mm
 V7
 12V
 6SEU/7SEU
MERCEDES
 35x52x20 n/a 5DN10

DENSO **6DN37**

 Ø 115/110mm
 V6
 12V
 6SE/7SE
AUDI/SEAT/SKODA/VW
 35x52x20 n/a 5DN09

DENSO **6DN38**

 Ø 105/100mm
 V6
 12V
 6SEU16C
MERCEDES
 35x52x12 n/a 5DN03
 5DN02

DENSO **6DN39**

 Ø 109/105mm
 V6
 12V
 SCS06D
FIAT/TOYOTA
 35x52x20 4DN07 5DN22

DENSO **6DN40**

 Ø 120/115mm
 V6
 12V
 6SE/7SE
AUDI/MERCEDES
 35x52x22 n/a 5DN10

DENSO **6DN41**

 Ø 120mm
 V6
 12V
 10PA
CHRYSLER
 30x52x22 4DN01 5DN13

DENSO **6DN42**

 Ø 125/120mm
 V6
 12V
 7SB16C/
 7SB17C
MERCEDES
 35x52x22 4DN01 5DN13

DENSO **6DN43**

 Ø 126/120mm
 V6
 12V
 7SBU16C
AUDI/VW
 35x52x22 4DN01 5DN13

DENSO **6DN44**

 Ø 125/120mm
 V6
 12V
 7SEU17C
MERCEDES
 35x52x12 n/a 5DN03
 5DN02

DENSO **6DN45**

 Ø 115/110mm
 V6
 12V
 7SEU17C
MERCEDES
 35x52x20 n/a 5DN10

DENSO **6DN46**

 Ø 104/100mm
 V7
 12V
 7SEU17C
MERCEDES
 35x52x12 n/a 5DN03
 5DN02

DENSO **6DN47**

 Ø 125/120mm
 V6
 12V
 10S15M/10S17C/
 10S20C
CHRYSLER
 30x52x22 4DN01 5DN13

DENSO **6DN48**

 Ø 100/100mm
 V6
 12V
 5SE12C
BMW
 35x52x12 n/a 5DN03
 5DN02

DENSO **6DN49**

 Ø 120/115mm
 V6
 12V
 SCS08
FIAT/TOYOTA
 35x52x20 4DN07 5DN22

DENSO **6DN50**

 Ø 135/130mm
 V7
 12V
 5SE12C
TOYOTA/LEXUS
 35x52x12 n/a 5DN11
 5DN02

DENSO **6DN51**

 Ø 120/115mm
 V7
 12V
 7SEU16C
AUDI/PORSCHE/VW
 35x52x22 n/a 5DN04
 5DN01

DENSO **6DN52**

 Ø 125/120mm
 V7
 12V
 7SEU17C
AUDI/VW
 35x52x22 n/a 5DN04
 5DN01

DENSO **6DN53**

 Ø 134/130mm
 V6
 12V
 5SSL12C-J/
 SCSA
FIAT/TOYOTA
 35x52x20 4DN07 5DN22

DENSO **6DN54**

 Ø 115/110mm
 V6
 12V
 6SE/7SE
AUDI/SEAT/SKODA/VW
 35x52x22 n/a 5DN06
 5DN05

DENSO **6DN55**

 Ø 108/103mm
 V6
 12V
MERCEDES
 35x52x22 n/a 5DN04
 5DN01

DENSO **6DN56**

 Ø 135/130mm
 12V
 24V
 10PA
MERCEDES
 35x52x22 4DN20 5DN13

DENSO **6DN57**

 Ø 142 mm
 11A
 24V
ISUZU
 30x52x22 4DN20 5DN13

DENSO **6DN58**

 Ø 110/110mm
 12V
 7SEU17C
BMW
 35x52x12 n/a 5DN03
 5DN02

DENSO **6DN59**

 Ø 125/120mm
 12V
 10S13
SUZUKI
 30x52x22 4DN05 5DN20

DENSO **6DN60**

 Ø 130/126mm
 12V
 6SEU
AUDI
 35x52x20 n/a 5DN09

DENSO **6DN61**

 Ø 135/130mm
 24V
 7SBU16C
MERCEDES
 35x52x22 4DN20 5DN13

DENSO **6DN62**

 Ø 116/110mm
 12V
 7SEU17C
BMW
 35x52x12 n/a 5DN07
 5DN33

DENSO **6DN63**

 Ø 116/110mm
 12V
 7SEU17C
BMW
 35x52x12 n/a 5DN07
 5DN33

DENSO **6DN64**

 Ø 115/110mm
 12V
 7SEU
BMW
 35x52x22 n/a 5DN07
 5DN33

DENSO **6DN65**

 Ø 105/100mm
 12V
 7SEU17C
BMW
 35x52x12 n/a 5DN07
 5DN33

DENSO **6DN66**

 Ø 144/140mm
 24V
 10S15/17
CATERPILLAR
 30x52x22 4DN20 5DN13

DENSO **6DN67**

 Ø 125/120mm
 12V
 TSE14C
LEXUS/TOYOTA
 35x52x12 n/a 5DN19

DENSO **6DN68**

 Ø 125/120mm
 12V
 6SES14C
TOYOTA
 35x52x12 n/a 5DN19

DENSO **6DN69**

 Ø 136/130mm
 12V
 10PA17C
TOYOTA
 30x52x22 4DN01 5DN13

DENSO **6DN70**

 Ø 139 mm
 24V
 10S17C
SPEC.VEH.
 30x52x22 4DN20 5DN13

DENSO **6DN71**

 Ø 120/116mm
 12V
 SCS
TOYOTA/FIAT
 35x52x20 4DN07 5DN22

DENSO **6DN72**

 Ø 136/130mm
 12V
HONDA
 30x52x22 4DN06 5DN13

DENSO **6DN73**

 Ø 115/110mm
 12V
 6SEU
AUDI/VW
 35x52x22 n/a 5DN04
 5DN01

DENSO **6DN74**

 Ø 115/110mm
 V6
 12V
 6SEU
MERCEDES
 35x52x22 n/a 5DN03 5DN02

DENSO **6DN75**

 Ø 145/139mm
 V8
 12V
 10PA
JOHNDEERE
 30x52x22 4DN01 5DN13

DENSO **6DN76**

 Ø 86 mm
 N/A
 12V
 7SEU17C
AUDI/VW/LAMBORGHINI
 35x52x12 n/a 5DN23 5DN24

DENSO **6DN77**

 Ø 125/120mm
 V7
 12V
 6SEU16C
MERCEDES
 35x52x22 n/a 5DN04 5DN01

DENSO **6DN78**

 Ø 124/120mm
 V7
 12V
 10S11C
TOYOTA HILUX
 30x52x20 4DN07 5DN22

DENSO **6DN79**

 Ø 97/93mm
 V6
 12V
 SCSA06
TOYOTA/FIAT
 30x47x20 4DN04 5DN21

DENSO **6DN80**

 Ø 105/100mm
 V6
 12V
 5SE
MERCEDES
 35x52x22 n/a 5DN03 5DN02

DENSO **6DN81**

 Ø 115/110mm
 V6
 12V
MERCEDES
 35x52x22 n/a 5DN10

DENSO **6DN82**

 Ø 125/120mm
 V4
 12V
IVECO
 30x52x22 4DN01 5DN13

DENSO **6DN83**

 Ø 125/120mm
 V4
 12V
IVECO
 30x52x22 4DN01 5DN13

DENSO **6DN85**

 Ø 116/103mm
 V6
 12V
 7SEU16C
MERCEDES
 35x52x22 n/a 5DN04 5DN01

DENSO **6DN86**

 Ø 115/103mm
 V7
 12V
 7SEU16C
MERCEDES
 35x52x22 n/a 5DN04 5DN01

DENSO **6DN87**

 Ø 105/100mm
 V6
 12V
 7SEU17C
VW T5
 35x52x20 n/a 5DN09

DENSO **6DN88**

 Ø 135/130mm
 V6
 12V
 10S20H
CHRYSLER/DODGE
 30x52x22 4DN01 5DN13

DENSO **6DN89**

 Ø 120/115mm
 V5
 12V
 6SES14C
MERCEDES
 35x52x22 n/a 5DN10

DENSO **6DN90**

 Ø 114/110mm
 V6
 12V
MITSUBISHI
 30x52x22 4HA08 5HA01

DENSO **6DN91**

 Ø 115/110mm
 V6
 12V
 10SR17C
CHRYSLER/DODGE
 30x52x22 4DN01 5DN13

DENSO **6DN92**

 Ø 124/119mm
 V6
 12V
 5SEL12C
PEUGEOT/CITROEN
 35x52x12 n/a 5DN03 5DN02

DENSO **6DN93**

 Ø 114/109mm
 1V6
 12V
 6SES14C
AUDI/VW
 35x52x20 n/a 5DN27

DENSO **6DN94**

 Ø 100mm
 1V6
 12V
 5SE12C
CHRYSLER/DODGE/JEEP
 35x52x22 n/a 5DN04 5DN01

DENSO **6DN95**

 Ø 124mm
 1V8
 12V
 10PA15C
SPEC. VEH./JOHNDEER
 30x52x22 4DN01 5DN13

DENSO **6DN96**

 Ø 147mm
 1A
 12V
 10PA15C/
 10S15C
SPEC. VEH./JOHNDEER
 30x52x22 4DN01 5DN13

DENSO **6DN97**

 Ø 146mm
 1A
 12V
 10PA
SPEC. VEH./JOHNDEER
 30x52x22 4DN01 5DN13

DENSO **6DN98**

 Ø 146mm
 1A
 12V
 10PA17C
SPEC. VEH./JOHNDEER
 30x52x22 4DN01 5DN13

DENSO **6DN99**

 Ø 120mm
 1A
 12V
 10PA17C
SPEC. VEH./JOHNDEER
 30x52x22 4DN01 5DN13

DENSO **6DN100**

 Ø 146mm
 1A
 12V
 6E171
SPEC. VEH./JOHNDEER
 40x62x24

DENSO **6DN101**

 Ø 152mm
 1A
 24V
 5S15C
SPEC. VEH./JOHNDEER
 30x52x22 4DN20 5DN13

DENSO **6DN102**

 Ø 146mm
 1A
 12V
 10PA
SPEC. VEH./JOHNDEER
 30x52x22 4DN01 5DN13

DENSO **6DN103**

 Ø 135mm
 12A
 24V
 10S15C
SPEC. VEH.
 30x52x22 4DN20 5DN13

DENSO **6DN104**

 Ø 135/131mm
 V4
 24V
 10PA15/17
SPEC. VEH.
 30x52x22 4DN01 5DN13

DENSO **6DN105**

 Ø 116/112mm
 V4
 12V
 10PA17C
SPEC. VEH.
 30x52x22 4DN01 5DN13

DENSO **6DN106**

 Ø 132mm
 12A
 12V
 10PA15C
SPEC. VEH.
 30x52x22 4DN01 5DN13

DENSO **6DN107**

 Ø 115/110mm
 V6
 12V
 6SES16C
LEXUS/TOYOTA
 35x52x12 n/a 5DN19

DENSO **6DN108**

 Ø 120/115mm
 V7
 12V
 10SR15C
HONDA
 30x52x22 4DN01 5DN13

DENSO **6DN109**

 Ø 130mm
 V7
 12V
 10S17
TOYOTA
 30x52x22 4DN05 5DN20

DENSO **6DN110**

 Ø 110mm
 V5
 12V
 6SEU12C
MERCEDES
 35x52x20 n/a 5DN06 5DN05

DENSO **6DN111**

 Ø 135/130mm
 V6
 12V
 10S17C
CHRYSLER
 30x52x22 4DN01 5DN13

DENSO **6DN112**

 Ø 115/110mm
 V4
 12V
 5TSE10C
TOYOTA
 35x52x12 n/a 5DN28

DENSO **6DN113**

 Ø 115/110mm
 V6
 12V
 6SAS14C
AUDI
 35x52x20 4DN11 5DN29

DENSO **6DN114**

 Ø 125/120mm
 V6
 12V
 10S17C
CHRYSLER/MERCEDES
 30x52x22 4DN01 5DN13

DENSO **6DN115**

 Ø 115/110mm
 V6
 12V
 5TSE10C
TOYOTA
 35x52x12 n/a 5DN30

DENSO **6DN116**

 Ø 115/110mm
 V6
 12V
AUDI/SEAT/SKODA/VW
 35x52x22 n/a 5DN04 5DN01

DENSO **6DN117**

 Ø 115/110mm
 V6
 12V
 5SE12C
TOYOTA
 35x52x12 n/a 5DN11 5DN02

DENSO **6DN118**

 Ø 105/100mm
 V5
 12V
 5SE09C
MITSUBISHI/SMART
 35x52x12 n/a 5DN03 5DN02

DENSO **6DN119**

 Ø 105/100mm
 V6
 12V
 6SBU16C
VWT5
 35x52x20 n/a 5DN09

DENSO **6DN120**

 Ø 115/110mm
 V6
 12V
 5SE12C
FIAT/OPEL/SUZUKI
 35x52x22 n/a 5DN11 5DN02

DENSO **6DN121**

 Ø 110/110mm
 V4
 12V
 7SEU17C
BMW
 35x52x12 n/a 5DN07 5DN08

DENSO **6DN122**

 Ø 115/110mm
 V8
 12V
 7SE
AUDI/PORSCHE/VW
 35x52x20 n/a 5DN09

DENSO **6DN123**

 Ø 120/115mm
 V6
 12V
 6SAS14C/ 7SAS17C
MERCEDES/NISSAN
 35x52x20 n/a 5DN10

DENSO **6DN124**

 Ø 125/120mm
 V6
 12V
 7SBU16C
OPEL
 30x52x22 4DN01 5DN13

DENSO **6DN125**

 Ø 130/125mm
 V6
 12V
 6SE/7SEU
AUDI
 35x52x22 n/a 5DN03 5DN02

DENSO **6DN126**

 Ø 124/119mm
 V7
 12V
 6SEL14C
RENAULT
 35x52x20 n/a 5DN03 5DN02

DENSO **6DN127**

 Ø 120/115mm
 V5
 12V
 6SES
MERCEDES
 35x52x20 n/a 5DN10

DENSO **6DN128**

 Ø 115/110mm
 V6
 12V
 5TSE10C
TOYOTA
 35x52x12 n/a 5DN19

DENSO **6DN129**



Ø 115/110mm
 V6
 12V
 6SEU16C/
 7SES17C

MERCEDES

Ø 35x52x20  n/a  5DN09

DENSO **6DN130**



Ø 122/115mm
 V6
 12V
 6SEU14C/
 6SEU16C

AUDI/MERCEDES

Ø 35x52x20  n/a  5DN09

DENSO **6DN131**







Ø 113/109mm
 V8
 12V
 7SBU17C

BMW



Ø 35x52x22  4DN06  5DN20

DENSO **6DN132**



Ø 114/110mm
 V6
 12V
 DKV8/DKV10R/
 SCSA06/SCSB06

FIAT/SUBARU/TOYOTA

Ø 32x47x18  4ZX10  5DN22

DENSO **6DN133**



Ø 136mm
 1A
 12V
 10S17C

MITSUBISHI

Ø 30x52x22  4DN01  5DN13

DENSO **6DN134**



Ø 121/117mm
 V7
 12V
 10PA17C

KIA

Ø 30x52x22  4DN08  5DN13

DENSO **6DN135**



Ø 125/119mm
 V7
 12V
 10SRE/10S15/
 10S17/10S20

HONDA

Ø 30x52x22  4DN06  5DN20

DENSO **6DN136**



Ø 114/109mm
 V6
 12V
 5SEL09C

CITROEN/PEUGEOT

Ø 35x52x12  n/a  5DN03
 5DN02

DENSO **6DN137**



Ø 116/110mm
 V6
 12V
 7SEU17C

LANDROVER

Ø 35x52x12  n/a  5DN07
 5DN33

DENSO **6DN138**



Ø 115/110mm
 V6
 12V
 6SEU16C/
 7SES17C

MERCEDES

Ø 35x52x20  n/a  5DN09

DENSO **6DN139**



Ø 124/119mm
 V6
 12V
 5SEL12C/
 6SEL16C

CITROEN/PEUGEOT

Ø 35x52x12  n/a  5DN03
 5DN02

DENSO **6DN140**



Ø 115/110mm
 V6
 12V

BMW

Ø 35x52x20  n/a  5DN09

DENSO **6DN142**



Ø 115/110mm
 V8
 12V

BMW

Ø 35x52x20  n/a  5DN09

DENSO **6DN143**



Ø 114/110mm
 V6
 12V
 6SBU16C/
 7SBU17A

MERCEDES

Ø 35x55x22  4DN15  5DN25

DENSO **6DN144**



Ø 114/110mm
 V7
 12V
 6SBU16C/
 7SBU17A

MERCEDES

Ø 35x55x22  4DN15  5DN25

DENSO **6DN145**



Ø 119/114mm
 V6
 12V
 6SBH14C/
 6SBL14C

NISSAN/RENAULT

Ø 35x52x20  

DENSO **6DN146**







Ø 123/119mm
 V6
 12V
 7SAS17C

TOYOTA



Ø 35x52x20  

DENSO **6DN147**



Ø 115/110mm
 V6
 12V
 6SAS14C

AUDI

Ø 35x52x20  4DN16  5DN29

DENSO **6DN148**

 Ø 127/125mm
 V6
 12V
 6SAS14C
AUDI
 35x52x20 4DN16 5DN29

DENSO **6DN149**

 Ø 110mm
 V6
 12V
MERCEDES
 35x52x22 n/a 5DN03
 5DN02

DENSO **6DN150**

 Ø 115/110mm
 V6
 12V
MERCEDES
 35x52x20 4DN13 5DN20

DENSO **6DN151**

 Ø 115/110mm
 V7
 12V
MERCEDES
 35x52x22 n/a 5DN10

DENSO **6DN152**

 Ø 115/111mm
 V4
 12V
MERCEDES
 35x52x20 n/a 5DN10

DENSO **6DN153**

 Ø 113/110mm
 V6
 12V
BMW
 35x52x22 4DN10 5DN20

DENSO **6DN154**

 Ø 115/110mm
 V6
 12V
BMW
 35x52x20

DENSO **6DN155**

 Ø 122/119mm
 V6
 12V
CHRYSLER
 30x52x22 4DN10 5DN20

DENSO **6DN156**

 Ø 97/92mm
 V4
 12V
SUBARU
 30x47x20 4DN04 5DN21

DENSO **6DN157**

 Ø 120/116mm
 V5
 12V
FIAT
 35x52x20 4DN07 5DN22

DENSO **6DN158**

 Ø 125/119mm
 V6
 12V
CHRYSLER
 35x52x22 4DN19 5DN31

DENSO **6DN159**

 Ø 125/120mm
 V7
 12V
MITSUBISHI
 35x52x22 4DN01 5DN13

DENSO **6DN160**

 Ø 150mm
 V2
 24V
SPEC.VEH
 30x52x22 4DN20 5DN13

DENSO **6DN161**

 Ø 125/119mm
 V6
 12V
CHRYSLER
 35x52x20

DENSO **6DN162**

 Ø 115/110mm
 V6
 12V
 7SEU16C
MERCEDES
 30x52x22 n/a 5DN04
 5DN01

DENSO **6DN163**

 Ø 125/119mm
 V8
 12V
 10PA17C
JOHN DEERE
 30x52x22 4DN01 5DN13

DENSO **6DN164**

 Ø 115/110mm
 V7
 12V
 7SEU17C
BMW, LAND ROVER
 35x52x12 n/a 5DN07
 5DN33

DENSO **6DN165**

 Ø 116/110mm
 V7
 12V
BMW, JAGUAR,
 35x52x12 n/a 5DN07
 5DN33

DENSO **6DN166**



Ø 110/110mm
 1V6
 12V

BMW

35x52x12 n/a 5DN03
 5DN02

DENSO **NEW!!! v.01 6DN167**



Ø 120/115mm
 1V5
 12V

MERCEDES

35x52x20

DENSO **NEW!!! v.01 6DN168**



Ø 126/121mm
 1V6
 12V

PORSCHE

35x52x22 n/a 5DN03
 5DN02

DENSO **NEW!!! v.01 6DN169**



Ø 116/110mm
 1V6
 12V

FORD

35x52x22 4DN33 5DN13

DENSO **NEW!!! v.01 6DN170**



Ø 115/109mm
 1V6
 12V

FORD

35x52x20 4DN34 5DN39

DENSO **NEW!!! v.01 6DN172**



Ø 120/116mm
 1V6
 12V

FORD

35x52x22 n/a 5DN03
 5DN02

FORD FS **6FS01**



Ø 131/127mm
 1V6
 12V
 FS10

FORD

30x55x23 4FS03 5FS04

FORD FS **6FS02**



Ø 125/115mm
 1V6
 12V
 FS10

FORD

30x55x23 4FS01

FORD FS **6FS03**



Ø 131/127mm
 1V8
 12V
 FS15/FX15

FORD

30x55x23 4FS03

HALLA **6HA01**



Ø 124/120mm
 1V6
 12V
 HS-18

KIA/HYUNDAI

35x52x20 4HA02 5HA03

HALLA **6HA02**



Ø 128/124mm
 1V4
 12V
 HS-15

HYUNDAI

35x52x20 4HA02 5HA01

HALLA **6HA03**



Ø 127/123mm
 1V6
 12V
 HS-18

KIA/HYUNDAI

30x55x23 4HA01 5HA04

HALLA **6HA04**



Ø 127/124mm
 1V6
 12V
 HS-18

KIA/HYUNDAI

30x55x23 4HA01 5HA04

HALLA **6HA05**



Ø 115/110mm
 1V7
 12V
 HS-16/HS-18

KIA/HYUNDAI

35x52x12 n/a 5HA05
 5HA06

HALLA **6HA06**



Ø 130/124mm
 1V6
 12V
 10PA

KIA

30x52x22 4DN08 5DN13

HALLA **6HA07**



Ø 127/123mm
 1V4
 12V
 10PA

KIA

30x52x22 4DN08 5DN13

HALLA **6HA08**



Ø 124/119mm
 1V6
 12V
 10PA

KIA

30x52x22 4DN08 5DN13

HALLA **6HA09**



Ø 143/139mm
 1V5
 12V

HYUNDAI

30x55x23 4HA04 5HA02

HALLA **6HA10**

 Ø 125/121mm
 V6
 12V

HYUNDAI
 30x55x23 4HA04 5HA02

HALLA **6HA11**

 Ø 128/124mm
 V6
 12V
 6SEU16C

KIA
 35x52x22 4DN08 5DN13

HALLA **6HA12**

 Ø 128/124mm
 V5
 12V
 HS-15/HS-18

HYUNDAI/KIA
 30x55x23 4HA01 5HA04

HALLA **6HA13**

 Ø 122/118mm
 V6
 12V
 HS-18

HYUNDAI/KIA
 30x52x22 4HA03 5HA03

HALLA **6HA14**

 Ø 126/123mm
 V4
 12V
 HS

HYUNDAI/KIA
 30x52x22 4HA08 5DN13

HALLA **6HA15**

 Ø 142 mm
 1A
 12V
 HS-15

FORD
 30x55x23 4HA01 5HA09

HALLA **6HA16**

 Ø 118/115mm
 V6
 12V

HYUNDAI/KIA
 35x52x20 n/a 5HA07

HALLA **6HA17**

 Ø 127/123mm
 V6
 12V
 FS

HYUNDAI/KIA
 35x55x20 4HA01 5HA04

HALLA **6HA18**

 Ø 126/122mm
 V7
 12V
 HS-20

HYUNDAI
 30x52x22 4HA05 5HA11

HALLA **6HA19**

 Ø 124/118mm
 V6
 12V
 HS-15

FORD
 30x55x23 n/a 5HA04

HALLA **6HA20**

 Ø 130/124mm
 V6
 12V
 DVE-12

HYUNDAI/KIA
 35x52x22 n/a 5HA10

HALLA **6HA21**

 Ø 120/114mm
 V6
 12V
 DVE-16

HYUNDAI/KIA
 35x52x22 n/a 5HA10

HALLA **6HA22**

 Ø 123/119mm
 V6
 12V
 HCC VS18E

HYUNDAI/KIA
 35x52x20 n/a 5HA07

HALLA **6HA23**

 Ø 122/118mm
 V6
 12V

MAZDA
 30x52x22 4HA05 5HA03

HALLA **6HA24**

 Ø 138/133mm
 V6
 12V

MAZDA
 30x52x22 4HA05 5HA11

HALLA **6HA25**

 Ø 119/114mm
 V6
 12V

HYUNDAI
 35x55x20 n/a 5HA07

HALLA **6HA26**

 Ø 122/117mm
 V6
 12V

HYUNDAI
 35x52x22 4DN01 5DN13

HALLA **6HA27**

 Ø 122/118mm
 V5
 12V

KIA
 35x52x20 n/a 5HA07

HALLA **6HA28**

 Ø 123/117mm
 V5
 12V
KIA
 35x52x22 n/a 5HA10

HALLA **6HA29**

 Ø 128/122mm
 V5
 12V
KIA
 35x52x22 n/a 5HA10

HALLA **6HA30**

 Ø 123/117mm
 V5
 12V
KIA
 35x52x22 n/a 5HA10

HALLA **6HA31**

 Ø 134/128mm
 V6
 12V
CHRYSLER
 30x55x23 4HA04 5HA02

HALLA **6HA32**

 Ø 135/131mm
 V6
 12V
CHRYSLER
 30x55x23 4HA01 5HA15

HALLA **6HA33**

 Ø 114/110mm
 V6
 12V
MAZDA
 30x52x22 5HA01

HALLA **6HA34**

 Ø 119/115mm
 V5
 12V
MAZDA
 30x52x22 4HA05 5HA03

HALLA **6HA35** *NEW!!! v.01*

 Ø 115/111mm
 V4
 12V
 HS-11
HYUNDAI
 35x52x20 5

HALLA **6HA36** *NEW!!! v.01*

 Ø 129/124mm
 V6
 12V
 VS-12N
HYUNDAI
 35x52x20 5

HALLA **6HA37** *NEW!!! v.01*

 Ø 113/110mm
 V6
 12V
 DOOWON DV9
SEAT, SKODA, VOLKSWAGEN
 35x52x22 4HA10 5

HALLA **6HA38** *NEW!!! v.01*

 Ø 114/109mm
 V7
 12V
 HCC HS13N
FORD
 30x52x22 5

HALLA **6HA39** *NEW!!! v.01*

 Ø 122/118mm
 V6
 12V
HONDA
 30x52x22 5

KEIHIN **6KE01**

 Ø 112/108mm
 V7
 12V
 HS110R
HONDA
 35x50x20 4KE02 5KE01

KEIHIN **6KE02**

 Ø 105/100mm
 V7
 12V
 HS110R/TRS
HONDA
 35x50x20 4KE02 5KE01

KEIHIN **6KE03**

 Ø 117/111mm
 V5
 12V
 HS-090R
HONDA
 35x50x20 4KE04 5SD12

KEIHIN **6KE04**

 Ø 123/118mm
 V7
 12V
 TRS
HONDA
 35x55x20 4SD11 5KE01

MITUBISHI **6MI01**

 Ø 102/95mm
 V5
 12V
 MSC90C
MITSUBISHI
 35x50x20 4MI01 5MI02

MITUBISHI **6MI02**

 Ø 115/110mm
 V6
 12V
 MSC105C/
 MSC105CA
MITSUBISHI
 35x50x20 4MI02 5MI02

MITUBISHI **6MI03**

 Ø 105/100mm
 12V
 MSC90C

MITSUBISHI
 35x50x20 4MI02 5MI02

MITUBISHI **6MI04**

 Ø 99/95mm
 12V
 QS90

MITSUBISHI
 32x47x18 4MI03 5MI03

MITUBISHI **6MI05**

 Ø 102/95mm
 12V
 MSC130C/
 MSC90

MITSUBISHI
 35x50x20 4MI01 5MI02

MITUBISHI **6MI06**

 Ø 90/90mm
 12V
 MSC60CAS

SUZUKI
 35x50x20 4MI05 5MI01

MITUBISHI **6MI07**

 Ø 118/109mm
 12V
 MSC90C

MITSUBISHI
 40x62x24

MITUBISHI **6MI08** NEW!!! v.01

 Ø 90/90mm
 12V

MITSUBISHI
 35x50x20

PANASONIC **6PA01**

 Ø 104/100mm
 12V

MAZDA
 32x47x18 4PA04 5PA01

PANASONIC **6PA02**

 Ø 129/125mm
 12V

MAZDA
 35x55x20 4PA02 5PA03

PANASONIC **6PA03**

 Ø 104/100mm
 12V

MAZDA
 35x50x20 4PA04 5PA01

PANASONIC **6PA04**

 Ø 127/125mm
 12V

MAZDA
 32x55x23 4PA02 5PA06

PANASONIC **6PA05**

 Ø 119/114mm
 12V

MAZDA
 32x47x18 4PA04 5PA03

PANASONIC **6PA06**

 Ø 121/117mm
 12V

MAZDA
 32x47x18 4PA05 5PA03

PANASONIC **6PA07**

 Ø 118/115mm
 12V
 H12A

MAZDA
 32x47x18 4PA08 5PA01

PANASONIC **6PA08**

 Ø 104/100mm
 12V
 H12A

MAZDA
 32x47x18 4PA04 5PA01

PANASONIC **6PA09**

 Ø 110/110mm
 12V

SUZUKI
 32x47x18 4PA09 5PA07

PANASONIC **6PA10**

 Ø 110/110mm
 12V

SUZUKI
 32x47x18 4PA09 5PA07

PANASONIC **6PA11**

 Ø 122/118mm
 12V

MAZDA
 32x55x23 4PA07 5PA05

SCROLL **6SC01**

 Ø 109/95mm
 12V
 SCROLL

FORD
 35x50x20 4SC01 5SC01

SANDEN **6SD01**



Ø 119/119mm
 12V
 SD7V16

AUDI/SEAT/SKODA/VW

35x55x20 4SD01 5SD05

SANDEN **6SD02**



Ø 119/119mm
 12V
 SD7V16

AUDI/SEAT/SKODA/VW

35x55x20 4SD08 5SD11

SANDEN **6SD03**



Ø 113/110mm
 12V
 PXE13/16

AUDI/SEAT/SKODA

35x52x20 n/a 5SD01

SANDEN **6SD04**



Ø 126/126mm
 12V
 SD7V16

VW

35x55x20 4SD01 5SD11

SANDEN **6SD05**



Ø 106/100mm
 12V
 TRS105

SAAB

35x50x20

SANDEN **6SD06**



Ø 123/119mm
 12V
 SD7V16/
 SD6V12

FORD/MAZDA

35x55x20 4SD07 5SD04

SANDEN **6SD07**



Ø 124/120mm
 12V
 SD7V16

PEUGEOT/CITROEN

35x55x20 4SD07 5SD04

SANDEN **6SD08**



Ø 132mm
 12A
 12V
 SD7H15

SPEC.VEH.

35x55x20 4SD21 5SD04

SANDEN **6SD09**



Ø 109/105mm
 12V
 SD6V12

OPEL

35x50x20 4SD02 5SD04

SANDEN **6SD10**



Ø 113/110mm
 12V
 PXE14/16

AUDI/SEAT/SKODA/VW

35x52x20 n/a 5SD02

SANDEN **6SD11**



Ø 123/119mm
 12V
 24V
 SD7H15

SPEC.VEH.

35x55x20 4SD21 5SD04

SANDEN **6SD12**



Ø 123/119mm
 12V
 SD7H15

PEUGEOT/CITROEN

35x55x20 4SD09 5SD11

SANDEN **6SD13**



Ø 112/107mm
 12V
 TRSA09

HONDA

35x50x20 4KE02 5SD12

SANDEN **6SD14**



Ø 124/120mm
 12V
 PXE16/
 PXV16

OPEL/SAAB

35x52x20 4SD05 5SD03

SANDEN **6SD15**



Ø 129/125mm
 12V
 SD6V12

RENAULT

35x55x20 4SD07 5SD04

SANDEN **6SD16**



Ø 111/107mm
 12V
 TRS

HONDA

35x50x20 4SD19 5SD12

SANDEN **6SD17**



Ø 105/99mm
 12V
 TRS09

HONDA

35x52x20 4SD19 5SD12

SANDEN **6SD18**



Ø 132mm
 12A
 24V
 SD7H15

SPEC.VEH.

35x55x20 4SD21 5SD04

SANDEN **6SD19**

 Ø 123/119mm
 12V
 SD7H15
SPEC.VEH.
 35x55x20 4SD08 5SD04

SANDEN **6SD20**

 Ø 135/131mm
 12V
 SD7H15
VOLVO TRUCKS
 35x55x20 4SD21 5SD11

SANDEN **6SD21**

 Ø 124/120mm
 12V
 SD7V16
OPEL/SAAB
 35x52x20 4SD04 5SD20

SANDEN **6SD22**

 Ø 106/100mm
 12V
 TRS
HONDA
 35x50x20 4SD12 5SD13

SANDEN **6SD23**

 Ø 117/112mm
 12V
 TRS
HONDA
 35x55x20 4KE03 5SD12

SANDEN **6SD24**

 Ø 120/115mm
 12V
 TRS
HONDA
 35x55x20 4KE03 5SD12

SANDEN **6SD25**

 Ø 132mm
 12V
 SD7H15
VOLVO
 35x55x20 4SD08 5SD11

SANDEN **6SD26**

 Ø 120/120mm
 24V
 SD7H15
SPEC.VEH.
 35x55x20 4SD08 5SD11

SANDEN **6SD27**

 Ø 145/140mm
 24V
 SD7H15
SPEC.VEH.
 35x55x20 4SD21 5SD11

SANDEN **6SD28**

 Ø 147mm
 24V
 SD7H15
SPEC.VEH.
 35x55x20 4SD21 5SD11

SANDEN **6SD29**

 Ø 110/106mm
 12V
 TRS
HONDA
 35x50x20 4SD12 5SD13

SANDEN **6SD30**

 Ø 121/117mm
 12V
 SD7C16
CITROEN/PEUGEOT
 35x52x20 4SD06 5SD14

SANDEN **6SD31**

 Ø 153/138mm
 24V
 SD7H15
SPEC.VEH.
 35x52x20 4SD22 5SD11

SANDEN **6SD32**

 Ø 152mm
 12V
 SD7H15
SPEC.VEH.
 35x55x20 4SD08 5SD11

SANDEN **6SD33**

 Ø 117/111mm
 12V
 TRS
HONDA
 35x55x20 4KE03 5SD12

SANDEN **6SD34**

 Ø 123/119mm
 12V
SPEC.VEH.
 35x55x20 4SD13 5SD11

SANDEN **6SD35**

 Ø 120/120mm
 12V
 SD7V16
VW/FORD/SEAT
 35x55x20 4SD03 5SD11

SANDEN **6SD36**

 Ø 123/123mm
 24V
 SD5H14
SPEC.VEH.
 40x62x24 4SD20

SANDEN **6SD37**

 Ø 123/119mm
 V6
 12V
VW
 35x52x20 4SD04 5SD04

SANDEN **6SD38**

 Ø 123/119mm
 V6
 12V
 SD6C12
CITROEN/PEUGEOT
 35x52x20 4SD15 5SD04

SANDEN **6SD39**

 Ø 115/110mm
 V4
 12V
 SD7V16
CITROEN/FIAT/FORD/PEUGEOT
 35x55x20 4SD08 5SD11

SANDEN **6SD40**

 Ø 124/120mm
 V5
 12V
 PXV
OPEL
 35x52x20 4SD05 5SD21

SANDEN **6SD41**

 Ø 132mm
 12A
 24V
 SD5H14/
 SD5H15
SPEC.VEH.
 40x62x24 4SD20 5SD22

SANDEN **6SD43**

 Ø 123/120mm
 V6
 12V
 PXE16
OPEL
 35x52x20 n/a 5SD08

SANDEN **6SD44**

 Ø 114/110mm
 V3
 12V
 PXC16
VOLVO
 35x52x20 4SD33 5SD15

SANDEN **6SD45**

 Ø 152/148mm
 V8
 24V
 SD7H15
SPEC.VEH./RENAULT
 35x55x20 4SD21 5SD04

SANDEN **6SD46**

 Ø 140mm
 12A
 12V
 SD7H15
SPEC.VEH.
 35x55x20 4SD08 5SD11

SANDEN **6SD47**

 Ø 132mm
 1A
 24V
 SD7H15
SPEC.VEH./DAF
 35x55x20 4SD21 5SD11

SANDEN **6SD48**

 Ø 140mm
 V8
 24V
 SD7H15
SPEC.VEH.
 35x55x20 4SD22 5SD11

SANDEN **6SD49**

 Ø 152mm
 12A
 12V
 SD7H15
SPEC.VEH.
 35x55x20 4SD23

SANDEN **6SD50**

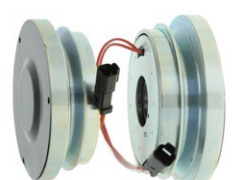
 Ø 153/133mm
 V8
 12V
 SD7H15
SPEC.VEH.
 35x55x20 4SD31 5SD23

SANDEN **6SD51**

 Ø 153/138mm
 11A
 24V
 SD7H15
SPEC.VEH.
 35x55x20 4SD23 5SD23

SANDEN **6SD52**

 Ø 106/100mm
 V6
 12V
 SD6V12
SEAT/VOLKSWAGEN
 35x50x20 4SD30 5SD17

SANDEN **6SD53**

 Ø 123/119mm
 V8
 12V
 SD5H14/
 SD508
SPEC.VEH.
 40x62x24 4SD14

SANDEN **6SD54**

 Ø 132/123mm
 V6
 12V
 PXC16
VOLVO
 35x52x20 4SD33 5SD15

SANDEN **6SD55**

 Ø 114/110mm
 V6
 12V
 PXC16
VOLVO
 35x52x20 4SD33 5SD15

SANDEN **6SD56**

 Ø 107/103mm
 1V6
 12V
 TRS
HONDA
 35x50x20 4KE02 5SD13

SANDEN **6SD57**

 Ø 113/109mm
 1V7
 12V
FORD
 35x50x20 4SD12 5SD24

SANDEN **6SD58**

 Ø 114/110mm
 1V6
 12V
 PXC14
MERCEDES
 35x52x20 4SD36 5SD19

SANDEN **6SD59**

 Ø 140/136mm
 1V7
 24V
 SD7H15
DAF
 35x55x20 4SD24 5SD09

SANDEN **6SD60**

 Ø 124/120mm
 1V11
 24V
 SD7H15
SPEC.VEH.
 35x55x20 4SD08 5SD11

SANDEN **6SD61**

 Ø 109/105mm
 1V7
 12V
 HS110R/
 TRSE07
HONDA
 35x50x20 4SD37 5SD25

SANDEN **6SD62**

 Ø 113/109mm
 1V6
 12V
 TRSE09/
 TRSA09
HONDA
 32x47x18 4SD38 5SD26

SANDEN **6SD64**

 Ø 129/125mm
 1V7
 12V
 SD6V12
RENAULT
 35x55x20 4SD07 5SD04

SANDEN **6SD65**

 Ø 127/127mm
 1V6
 12V
 SD7V16
VOLKSWAGEN
 35x55x20 4SD10 5SD04

SANDEN **6SD66**

 Ø 180/176mm
 1V8
 24V
 SD7H15
VOLVO
 35x55x20 4SD24 5SD09

SANDEN **6SD68**

 Ø 130/125mm
 1V12
 24V
CAT
 35x55x20 4SD22 5SD11

SANDEN **6SD69**

 Ø 123/120mm
 1V6
 12V
VOLVO
 35x52x20 4SD33

SANDEN **6SD70**

 Ø 131/111/127mm
 12X V5
 12V
AUDI/ VOLKSWAGEN
 35x55x20 n/a 5SD02

SANDEN **6SD71**

 Ø 153/153mm
 1V8
 24V
 SD7H15
SPEC.VEH.
 35x55x20 4SD23

SANDEN **6SD72**

 Ø 114/110mm
 1V6
 12V
 6V10
OPEL, SUBARU, SUZUKI
 35x52x20 4SD04

SANDEN **6SD73**

 Ø 125/121mm
 1V5
 12V
 PXV16
OPEL, SAAB
 35x52x20 4SD05 5SD03

SANDEN **6SD74**

 Ø 114/110mm
 1V6
 12V
 SD6V12
AUDI, VOLKSWAGEN
 35x52x20 4SD01 5SD04

SANDEN **6SD75**

 Ø 111/106mm
 1V4
 12V
 TRS090
HONDA
 35x50x20 4KE02

SANDEN **6SD76**



Ø 140/136mm
 1V7
 12V
 SD7H15
 SD6V12

SPEC.VEH.

35x55x20 4SD08 5SD04

SANDEN **NEW!!! v.01** **6SD77**



Ø 124/120mm
 1V6
 12V
 PXC16

OPEL, SAAB

35x52x20

SANDEN **NEW!!! v.01** **6SD78**



Ø 124/120mm
 1V5
 12V
 PX

OPEL

35x52x20

SANDEN **NEW!!! v.01** **6SD79**



Ø 136/132mm
 1V8
 24V
 SD7H15

SPEC.VEH.

35x52x20

SANDEN **NEW!!! v.01** **6SD80**



Ø 113/108mm
 1V6
 12V

VOLKSWAGEN

30x47x20

SANDEN **NEW!!! v.01** **6SD81**



Ø 129/125/119mm
 2X V5
 12V
 PXC16

VOLVO

35x55x20

SEIKO-SEIKI **6SS01**



Ø 110/110mm
 1V5
 12V

BMW

30x55x23 5SS02

SEIKO-SEIKI **6SS02**



Ø 110/110mm
 1V5
 12V

BMW

30x55x20 4SS02 5SS02

SEIKO-SEIKI **6SS03**



Ø 124/120mm
 1V4
 12V
 SS-96

SMART

32x47x18 4ZX09 5SS03

SEIKO-SEIKI **6SS04**



Ø 114/108mm
 1V6
 12V

CITROEN/PEUGEOT

32x47x18 4SS04 5SS04

SEIKO-SEIKI **6SS05**



Ø 115/115mm
 1V4
 12V
 SS96D1

BMW

32x55x23 4SS03 5SS01

UNICLA **NEW!!! v.01** **6UN01**



Ø 168/168mm
 12A
 24V
 UX310/330U

SPEC.VEH.

50x80x16(2PCS) 5UN02

UNICLA **NEW!!! v.01** **6UN02**



Ø 172/168mm
 1V8
 24V
 UX310/330U

SPEC.VEH.

50x80x16(2PCS) 5UN02

VISTEON **6VI01**



Ø 117/108mm
 1V5
 12V
 VS-16

FORD/VOLVO

35x55x20 4VI01 5VI01

VISTEON **6VI02**



Ø 117/108mm
 1V6
 12V
 VS16

FORD/VOLVO

35x55x20 4VI01 5VI01

VISTEON **6VI03**



Ø 117/108mm
 1V6
 12V
 VS-16

FORD

35x55x20 5VI04

VISTEON **6VI04**



Ø 134/130mm
 1V7
 12V
 VS16

FORD

35x55x20 4VI02 5VI02

VISTEON **6VI05**



Ø 117/108mm
 1V6
 12V
 VS-16

FORD

35x55x20 4VI01 5VI04

VISTEON **6VI06**



Ø 135/127mm
 V6
 12V
 VS-16

FORD

35x55x20 4VI02 5VI06

VISTEON **6VI07**



Ø 117/108mm
 V6
 12V

FORD

35x55x20 4VI01 5VI07

VISTEON **6VI08**



Ø 116/110mm
 V6
 12V
 VS

BMW

35x52x20 n/a 5VI05

VISTEON **6VI09**



Ø 114/109mm
 V7
 12V
 VS

FORD

35x52x22 4VI05 5VI08

VISTEON **6VI10**



Ø 117/108mm
 V4
 12V
 VS-16

FORD

35x55x20 4VI01 5VI04

VISTEON **6VI11**



Ø 131/127mm
 V7
 12V
 VS16

FORD

35x55x20 4VI01

VISTEON **6VI13**



Ø 123/119mm
 V6
 12V

CHRYSLER

30x52x22 5HA01

VISTEON **6VI14**



Ø 117/108mm
 V6
 12V

FORD

35x55x20 4VI04 5VI07

VISTEON **6VI15**



Ø 125/118mm
 V6
 12V
 VS16

FORD

35x55x20 4VI03

VISTEON **6VI16**



Ø 116/110mm
 V6
 12V
 F56

BMW, MINI

35x52x20

YORK **6YO01**



Ø 152mm
 12A
 24V
 ER210R

SPEC.VEH.

30x55x23 4YO20

YORK **6YO02**



Ø 178mm
 12A
 12V
 ER210R

SPEC.VEH.

30x55x23 4YO01

YORK **6YO03**



Ø 152/146mm
 V6
 12V
 ER210R

SPEC.VEH.

30x55x23 4YO01

YORK **6YO04** *NEW!!! v.01*



Ø 152mm
 12A
 12V
 ER210R

SPEC.VEH.

30x55x23 4YO01

ZEXEL **6ZX01**



Ø 125/120mm
 V7
 12V
 DCS17/
 KC88

MERCEDES

35x52x20 n/a 5ZX02

ZEXEL **6ZX02**



Ø 123/119mm
 V6
 12V
 DKS15CH/
 DKS17CH

VOLVO

35x55x20 4ZX04 5ZX05

ZEXEL **6ZX03**



Ø 123/119mm
 V4
 12V
 DCW17

AUDI/VW

35x55x20 4ZX14 5ZX16

ZEXEL **6ZX04**



Ø 135mm
 12A
 24V
 TM08/13/
 15/16HD

SPEC.VEH.

35x55x20 4ZX21 5ZX03

ZEXEL **6ZX05**



Ø 114/110mm
 1V6
 12V
 DCS17E

AUDI/SEAT

35x52x20 n/a 5ZX01

ZEXEL **6ZX06**



Ø 115/110mm
 1V6
 12V
 DCS-17/
 KC-88

MERCEDES

35x52x20 n/a 5ZX02

ZEXEL **6ZX07**



Ø 114/110mm
 1V5
 12V
 DCS-17EC

VOLVO

35x55x20 4ZX03 5ZX04

ZEXEL **6ZX08**



Ø 135mm
 2A
 12V
 TM08/13/
 15/16HD

SPEC.VEH.

35x55x20 4ZX01 5ZX03

ZEXEL **6ZX09**



Ø 123/119mm
 1V8
 12V
 TM08/13/
 15/16HD

SPEC.VEH.

35x55x20 4ZX01 5ZX03

ZEXEL **6ZX10**



Ø 122/119mm
 1V8
 24V
 TM08/13/
 15/16HD

SPEC.VEH.

35x55x20 4ZX21 5ZX03

ZEXEL **6ZX11**



Ø 125/120mm
 1V4
 12V
 DKV08R

NISSAN

32x47x18 4ZX07 5ZX08

ZEXEL **6ZX12**



Ø 119/115mm
 1V7
 12V
 KC-88/
 DCS-17

OPEL/RENAULT

35x55x20 4ZX02 5ZX07

ZEXEL **6ZX13**



Ø 119/115mm
 1V6
 12V
 KC-88/
 DCS-17EC

OPEL/RENAULT/NISSAN

35x55x20 4ZX02 5ZX07

ZEXEL **6ZX14**



Ø 104/100mm
 1V4
 12V
 DKV-10R

SUBARU

32x47x18 4ZX10 5ZX09

ZEXEL **6ZX15**



Ø 104/100mm
 1V7
 12V
 DKV-10R

SUBARU

32x47x18 4ZX10 5ZX12

ZEXEL **6ZX16**



Ø 155/151mm
 1V8
 24V
 TM31/TM32

SPEC.VEH.

40x68x30 4ZX24 5ZX10

ZEXEL **6ZX17**



Ø 104/100mm
 1V4
 12V
 DKV-08R

SUZUKI

32x47x18 4ZX09 5ZX11

ZEXEL **6ZX18**



Ø 126/123mm
 1V6
 12V
 KC-88

RENAULT

35x55x20 4ZX05 5ZX07

ZEXEL **6ZX19**



Ø 114/110mm
 1V5
 12V
 DCS-14IC

SUZUKI

35x55x22 4ZX03 5ZX17

ZEXEL **6ZX20**



Ø 129/125mm
 1V6
 12V
 DCS-17EC

RENAULT

32x55x20 4ZX15 5ZX18

ZEXEL **6ZX21**



Ø 139/135mm
 1V7
 12V
 DVE-16/
 DCS-17D

NISSAN

35x55x20 4ZX13 5ZX03

ZEXEL **6ZX22**



Ø 129/125mm
 1V6
 12V
 DKS-17D

RENAULT

35x55x20 4ZX06

ZEXEL **6ZX23**

 Ø 113/108mm
 12V
 DKV-09/
 DKV-10
NISSAN
 32x47x18

ZEXEL **6ZX25**

 Ø 125mm
 12V
 DKS15D
MITSUBISHI
 35x55x20 4ZX16 5ZX19

ZEXEL **6ZX26**

 Ø 134/130mm
 12V
 KC-88
VOLVO
 35x55x22 4ZX11 5ZX04

ZEXEL **6ZX27**

 Ø 129/119/125mm
 12V
 DKS15D
VOLVO
 35x55x20 4ZX08 5ZX22

ZEXEL **6ZX28**

 Ø 119/115mm
 12V
 DKS17D
NISSAN
 35x55x20 4ZX17 5ZX20

ZEXEL **6ZX29**

 Ø 114/109mm
 12V
 DCS-17ECR
VOLVO
 35x55x20 4ZX03 5ZX04

ZEXEL **6ZX30**

 Ø 114/110mm
 12V
SUBARU
 32x55x20 4ZX18 5ZX21

ZEXEL **6ZX31**

 Ø 129/124mm
 12V
 DKV-11R
DACIA, NISSAN, RENAULT
 35x55x20 4ZX05 5ZX07

ZEXEL **6ZX32**

 Ø 129/125mm
 12V
RENAULT
 35x55x20

ZEXEL **6ZX33**

 Ø 120/116mm
 12V
RENAULT
 35x55x20

ZEXEL **6ZX34**

 Ø 104/100mm
 12V
RENAULT
 32x47x18

ZEXEL **6ZX35**

 Ø 144mm
 12V
 DKS 15/17
SPEC.VEH.
 35x55x20

ZEXEL **6ZX36**

 Ø 139/135mm
 12V
 DKS-17D
NISSAN
 35x55x20 4ZX13 5ZX03

ZEXEL **6ZX37**

 Ø 129/124mm
 12V
 KC-88
NISSAN, RENAULT
 35x55x20 4ZX05

ZEXEL **6ZX38**

 Ø 158mm
 12V
 TM 31/32
SPEC.VEH.
 40x68x30 5ZX10

ZEXEL **6ZX39**

 Ø 110mm
 12V
 DCS-14IC
SUZUKI
 35x55x22

ZEXEL **6ZX40**

 Ø 104/100mm
 12V
 DKV-09Z
DACIA, RENAULT
 32x47x18

ZEXEL **6ZX41**

 Ø 137/133mm
 12V
 DKS-17DS
MAZDA
 35x55x20

ZEXEL

6ZX42



Ø 129/124mm

V4

12V

DKV14G

SUBARU

35x55x20



ZEXEL

NEW!!!
v. 01
6ZX43



Ø 129/125mm

V6

12V

VCS 14EC

NISSAN, RENAULT

35x55x20



4ZX26



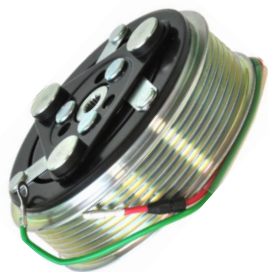

CLUTCH ASSY BY CAR

Sprzęgła kompletne po marce Samochodów

CAR	CLUTCH
ALFA ROMEO	6DL28
AUDI	6DL07, 6DL18, 6DN01, 6DN03, 6DN05, 6DN12, 6DN13, 6DN14, 6DN15, 6DN37, 6DN40, 6DN43, 6DN51, 6DN52, 6DN54, 6DN60, 6DN73, 6DN76, 6DN93, 6DN113, 6DN116, 6DN122, 6DN125, 6DN130, 6DN147, 6DN148, 6SD01, 6SD02, 6SD03, 6SD10, 6SD70, 6SD74, 6ZX03, 6ZX05
BMW	6CL01, 6CL05, 6CL10, 6CL11, 6CL12, 6CL15, 6CL19, 6CL20, 6DN11, 6DN27, 6DN29, 6DN48, 6DN58, 6DN62, 6DN63, 6DN64, 6DN65, 6DN121, 6DN131, 6DN140, 6DN142, 6DN153, 6DN154, 6DN164, 6DN165, 6DN166, 6SS01, 6SS02, 6SS05, 6VI08, 6VI16
CHEVROLET	6DL10, 6DL11, 6DL12, 6DL16, 6DL19, 6DL25, 6DL26
CHRYSLER	6DN41, 6DN47, 6DN88, 6DN88, 6DN91, 6DN91, 6DN94, 6DN94, 6DN94, 6DN111, 6DN114, 6DN155, 6DN158, 6DN161, 6HA31, 6HA32, 6VI13
CITROEN	6DN92, 6DN136, 6DN139, 6SD07, 6SD12, 6SD30, 6SD38, 6SD39, 6SS04
DACIA	6ZX31, 6ZX40
DAF	6SD59
FIAT	6DL28, 6DL32, 6DN19, 6DN25, 6DN39, 6DN49, 6DN53, 6DN71, 6DN79, 6DN120, 6DN132, 6DN157, 6SD39
FORD	6DN169, 6DN170, 6FS01, 6FS02, 6FS03, 6HA15, 6HA19, 6HA38, 6SC01, 6SD06, 6SD35, 6SD39, 6SD57, 6VI01, 6VI02, 6VI03, 6VI04, 6VI05, 6VI06, 6VI07, 6VI09, 6VI10, 6VI11, 6VI14, 6VI15
HONDA	6DL23, 6DL24, 6DN23, 6DN72, 6DN108, 6DN135, 6KE01, 6KE02, 6KE03, 6KE04, 6SD13, 6SD16, 6SD17, 6SD22, 6SD23, 6SD24, 6SD29, 6SD33, 6SD56, 6SD61, 6SD62, 6SD75
HYUNDAI	6HA01, 6HA02, 6HA03, 6HA04, 6HA05, 6HA09, 6HA10, 6HA12, 6HA13, 6HA14, 6HA16, 6HA17, 6HA18, 6HA20, 6HA21, 6HA22, 6HA25, 6HA26, 6HA35, 6HA36
ISUZU	6DN57
IVECO	6DN22, 6DN82, 6DN83
JAGUAR	6DN165
KIA	6DN134, 6HA01, 6HA03, 6HA04, 6HA05, 6HA06, 6HA07, 6HA08, 6HA11, 6HA12, 6HA13, 6HA14, 6HA16, 6HA17, 6HA20, 6HA21, 6HA22, 6HA27, 6HA28, 6HA29, 6HA30
LAMBORGHINI	6DN76
LAND ROVER	6DN137, 6DN164
LEXUS	6DN50, 6DN67, 6DN107
MASERATI	6DL29, 6DL31

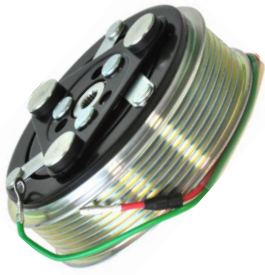

CLUTCH ASSY BY CAR

Sprzęgła kompletne po marce Samochodów

CAR	CLUTCH
MAZDA	6HA23, 6HA24, 6HA33, 6HA34, 6PA01, 6PA02, 6PA03, 6PA04, 6PA05, 6PA06, 6PA07, 6PA08, 6PA11, 6SD06, 6ZX41
MERCEDES	6DN04, 6DN05, 6DN06, 6DN10, 6DN16, 6DN18, 6DN20, 6DN26, 6DN30, 6DN36, 6DN38, 6DN40, 6DN42, 6DN44, 6DN45, 6DN46, 6DN55, 6DN56, 6DN61, 6DN74, 6DN77, 6DN80, 6DN81, 6DN85, 6DN86, 6DN89, 6DN110, 6DN114, 6DN123, 6DN127, 6DN129, 6DN130, 6DN138, 6DN143, 6DN144, 6DN149, 6DN150, 6DN151, 6DN152, 6DN162, 6DN167, 6SD58, 6ZX01, 6ZX06
MINI	6DL30, 6VI16
MITSUBISHI	6DN90, 6DN118, 6DN133, 6DN159, 6MI01, 6MI02, 6MI03, 6MI04, 6MI05, 6MI07, 6MI08, 6ZX25
NISSAN	6CL02, 6CL03, 6CL04, 6CL06, 6CL07, 6CL09, 6CL13, 6CL14, 6CL16, 6CL17, 6CL18, 6DL02, 6DL08, 6DN123, 6DN145, 6ZX11, 6ZX13, 6ZX21, 6ZX23, 6ZX28, 6ZX31, 6ZX36, 6ZX37, 6ZX43
OPEL	6DL01, 6DL03, 6DL04, 6DL05, 6DL06, 6DL09, 6DL13, 6DL15, 6DL16, 6DL19, 6DL20, 6DL27, 6DN19, 6DN25, 6DN33, 6DN120, 6DN124, 6SD09, 6SD14, 6SD21, 6SD40, 6SD43, 6SD72, 6SD73, 6SD77, 6SD78, 6ZX12, 6ZX13
PEUGEOT	6DN92, 6DN136, 6DN139, 6SD07, 6SD12, 6SD30, 6SD38, 6SD39, 6SS04
PORSCHE	6DN51, 6DN122, 6DN168
RENAULT	6CL08, 6DL02, 6DL08, 6DL14, 6DL17, 6DL22, 6DN28, 6DN126, 6DN145, 6SD15, 6SD45, 6SD64, 6ZX12, 6ZX13, 6ZX18, 6ZX20, 6ZX22, 6ZX31, 6ZX32, 6ZX33, 6ZX34, 6ZX37, 6ZX40, 6ZX43
SAAB	6SD05, 6SD14, 6SD21, 6SD73, 6SD77
SEAT	6DL07, 6DL18, 6DN03, 6DN37, 6DN54, 6DN116, 6HA37, 6SD01, 6SD02, 6SD03, 6SD10, 6SD35, 6SD52, 6ZX05
SKODA	6DL07, 6DL18, 6DN03, 6DN37, 6DN54, 6DN116, 6HA37, 6SD01, 6SD02, 6SD03, 6SD10
SMART	6DN118, 6SS03
SPECIAL VEHICLES	6DL21, 6DN66, 6DN70, 6DN75, 6DN95, 6DN96, 6DN97, 6DN98, 6DN99, 6DN100, 6DN101, 6DN102, 6DN103, 6DN104, 6DN105, 6DN106, 6DN160, 6DN163, 6SD08, 6SD11, 6SD18, 6SD19, 6SD20, 6SD26, 6SD27, 6SD28, 6SD31, 6SD32, 6SD34, 6SD36, 6SD41, 6SD45, 6SD46, 6SD47, 6SD48, 6SD49, 6SD50, 6SD51, 6SD53, 6SD60, 6SD68, 6SD71, 6SD76, 6SD79, 6UN01, 6UN02, 6YO01, 6YO02, 6YO03, 6YO04, 6ZX04, 6ZX08, 6ZX09, 6ZX10, 6ZX16, 6ZX35, 6ZX38
SUBARU	6DN132, 6DN156, 6SD72, 6ZX14, 6ZX15, 6ZX30, 6ZX42
SUZUKI	6DN59, 6DN120, 6MI06, 6PA09, 6PA10, 6SD72, 6ZX17, 6ZX19, 6ZX39
TOYOTA	6DN07, 6DN08, 6DN09, 6DN17, 6DN21, 6DN24, 6DN31, 6DN34, 6DN35, 6DN39, 6DN49, 6DN50, 6DN53, 6DN67, 6DN68, 6DN71, 6DN78, 6DN79, 6DN107, 6DN109, 6DN112, 6DN115, 6DN117, 6DN128, 6DN132, 6DN146
VOLVO	6SD25, 6SD44, 6SD54, 6SD55, 6SD66, 6SD69, 6SD81, 6VI01, 6VI02, 6ZX02, 6ZX07, 6ZX26, 6ZX27, 6ZX29
VW	6DL07, 6DL18, 6DN02, 6DN03, 6DN15, 6DN32, 6DN37, 6DN43, 6DN51, 6DN52, 6DN54, 6DN73, 6DN76, 6DN87, 6DN93, 6DN116, 6DN119, 6DN122, 6HA37, 6SD01, 6SD02, 6SD04, 6SD10, 6SD35, 6SD37, 6SD52, 6SD65, 6SD70, 6SD74, 6SD80, 6ZX03



7XX01
VOLKSWAGEN
1-pin



7XX02
MITSUBISHI
1-pin



7XX03
VOLKSWAGEN
2-pin



7XX04
VOLKSWAGEN
2-pin



7XX05
CHRYSLER
2-pin



7XX06
OPEL
2-pin



7XX07
HYUNDAI
1-pin



7XX08
NISSAN
1-pin



7XX09
KIA
1-pin



7XX10
PEUGEOT
2-pin



7XX11
HONDA
1-pin



7XX12
FORD
2-pin



7XX13
BMW/MERCEDES
1-pin



7XX14
HYUNDAI
1-pin



7XX15
FORD
2-pin



7XX16
RENAULT
2-pin



7XX17
TOYOTA
3-pin



7XX18
VOLKSWAGEN
2-pin



7XX19
MERCEDES
1-pin



7XX20
BMW
2-pin



7XX21
BMW
2-pin





8XX01

HAND
CRIMPERS



8XX02

CABLES
SERVICE WITH
PRESSURE
GAUGE



8XX03

COMPRESSOR
CLUTCH
TOOL SET



8XX04

TESTER
CONTROL
VALVES



8XX05

CABLES FOR
TESTER 8XX04



8XX06

UV LED
FLASHLIGHT



8XX07

COMPRESSOR
CLUTCH
TOOL SET



8XX08

AUTOMATIC
HALOGEN
LEAK
DETECTOR
KIT



8XX09

WEIGHT



8XX10

1L PAG 100



8XX11

COMPRESSOR
CLUTCH TOOL
SET



NEW !!!
v. 01

8XX12

METRIC
THREAD
CHASER SET
MT1405



8XX14

O-rings PICK
SET (1 SET)



8XX15

1L PAG 46



8XX16

SHAFT SEAL
TOOL KITS



NEW !!!
v. 01

8XX18

SEAL
REPLACEMENT
KIT
MT1131



8XX21

SPRINGLOCK
#6 (3/8")
(1 Set/20pcs)



8XX22

SPRINGLOCK
#8 (1/2")
(1 Set/20pcs)



8XX23

SPRINGLOCK
#10 (5/8")
(1 Set/20pcs)



8XX24

SPRINGLOCK
#12 (3/4")
(1 Set/20pcs)



8XX25

SHAFT SEAL
TOOL KITS

NEW !!!
v. 01 **8XX27**



WASHER GM
23,5 mm
MT0395

NEW !!!
v. 01 **8XX28**



WASHER GM
19 mm
MT0370

NEW !!!
v. 01 **8XX30**



WASHER GM
25 mm
MT0371

NEW !!!
v. 01 **8XX35**



WASHER GM
16 mm
MT0369

NEW !!!
v. 01 **8XX60**



O-RING
DOUBLE
MT1103

NEW !!!
v. 01 **8XX66**



CLUTCH SHIM
M6
(6,9*11,3*0,4)
(1 Set/20pcs)
MT0080

NEW !!!
v. 01 **8XX67**



CLUTCH SHIM
M8
(8,5*12,3*0,2)
(1 Set/20pcs)
MT0082

NEW !!!
v. 01 **8XX68**



CLUTCH SHIM
M8
(8,5*12,3*0,4)
(1 Set/20pcs)
MT0083

NEW !!!
v. 01 **8XX69**



VALVE
SCREWDRIVER

NEW !!!
v. 01 **8XX77**



FLARED
FITTING
WASHER
5/16"
(1 Set/5pcs)
MT8000

NEW !!!
v. 01 **8XX78**



FLARED
FITTING
WASHER
3/8"
(1 Set/5pcs)
MT8001

NEW !!!
v. 01 **8XX79**



FLARED
FITTING
WASHER
1/2"
(1 Set/5pcs)
MT8002

NEW !!!
v. 01 **8XX80**



FLARED
FITTING
WASHER
5/8"
(1 Set/5pcs)
MT8003

NEW !!!
v. 01 **8XX81**



FLARED
FITTING
WASHER
1/4"
(1 Set/5pcs)
MT8009

NEW !!!
v. 01 **8XX82**



O-RING
(1 Set/6pcs)
MT0200

NEW !!!
v. 01 **8XX83**



O-RING
(1 Set/10pcs)
MT0325

NEW !!!
v. 01 **8XX84**



O-RING
(1 Set/10pcs)
MT0249

8XX100



O-rings

8XX101



O-rings

8XX102



O-rings

8XX103



O-rings



8XX104

GM SLIM-LINE
WASHER KIT



8XX105

VALVE COR
ASSORTMENT
KIT
(8 DIFFERENT
CORES)

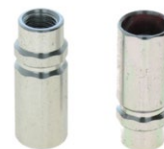

8XX106

FORD, SEAT,
SKODA, VW
VALVE R134A
LOW SIDE
PRIMARY
SEAL



8XX107

R134A RETRO
FITTING 7/16
LOW SIDE
STEEL
(1 Set/5pcs)



8XX108

FORD, SEAT,
SKODA, VW
VALVE R134A
HIGH SIDE
PRIMARY
SEAL



8XX109

R134A RETRO
FITTING 7/16
HIGH SIDE
STEEL
(1 Set/5pcs)



8XX110

OPEL O-rings
MT2170



8XX111

MANUAL LOW
SIDE COUPLER
FOR R1234YF



8XX112

MANUAL
HIGH SIDE
COUPLER FOR
R1234YF



8XX113

R134A VALVE
CORE VOLVO/
PEUGEOT
(1 Set/5pcs)



8XX114

VALVE CORE
GM/FORD JRA
IMPORT
(1 Set/5pcs)



8XX115

VALVE CORE
(1 Set/5pcs)



8XX118

MANUAL LOW
SIDE COUPLER
FOR R134a



8XX119

MANUAL LOW
SIDE COUPLER
FOR R134a 1/4
FL



8XX120

MANUAL
HIGH SIDE
COUPLER FOR
R134a 1/4 FL



8XX121

MANUAL
HIGH SIDE
COUPLER FOR
R134a



8XX122

MANUAL
HIGH SIDE
COUPLER FOR
R134a
UNIVRSAL



8XX123

MANUAL LOW
SIDE COUPLER
FOR R134a
UNIVRSAL



8XX124

MANUAL
HIGH&LOW
SIDE COUPLER
FOR R134a
UNIVRSAL



8XX125

SIGHT
WINDOW AIR
CONDITIONING



9XX02

3-pin
OPEL:
6850512/
9131721
RENAULT:
7700417506/
7701205751

OPEL/RENAULT



9XX03

3-pin
VW:
1J0959126/
8Z0959126

VW



9XX04

3-pin
CITROEN/
PEUGEOT:
6455.Z3
FIAT:
9647971280

CITROEN/PEUGEOT/FIAT



9XX05

4-pin
VW:
1H0959139A/
1H0959139B

VW



9XX06

3-pin
VOLVO:
31292004

VOLVO



9XX07

3-pin
RENAULT:
921361722R

RENAULT



9XX08

3-pin
MERCEDES:
2110000283

MERCEDES



9XX09

3-pin
MERCEDES:
6395420818/
1408300072

MERCEDES



9XX10

2-pin
HONDA:
MT0358

HONDA



9XX11

3-pin
JEEP:
5072138AA

JEEP



9XX12

4-pin
FORD:
8L8Z19D594A/
XS4Z19D594AA

FORD



9XX13

3-pin
FORD:
6F9319D594AA/
6F9319D594AA

FORD



9XX14

3-pin
BMW:
64536909257

BMW



9XX15

3-pin
NISSAN:
92136-6J010

NISSAN



9XX16

4-pin
TOYOTA:
499000-7141

TOYOTA



9XX17

4-pin
OPEL:
1854780/
90506752

OPEL



9XX18

3-pin
VOLVO:
30899051

VOLVO



9XX19

5-pin
FIAT:
46476438

FIAT



9XX20

4-pin
OPEL:
1854779/
90506751

OPEL



9XX21

4-pin

UNIVERSAL



9XX22

4-pin

UNIVERSAL

9XX23

4-pin
NISSAN:
92137-4S100

NISSAN

9XX24

2-pin
FORD:
7085739/
4713511

FORD

9XX25

3-pin
VW:
3R0 959 126

VW

9XX26

3-pin
HONDA:
80450S7S003/
80450SFE003

HONDA

9XX28

2-pin

UNIVERSAL

9XX29

3-pin
VW:
4H0959126A

VW

9XX30

3-pin
CHRYSLER/
JEEP:
MT0614

CHRYSLER/JEEP

9XX31

2-pin
BMW:
64538390971

BMW

9XX32

4-pin
HONDA:
88645-60030

HONDA

9XX33

4-pin
VW:
3D0959126B

VW

9XX34

2-pin
CHRYSLER:
4773101/
4798599

CHRYSLER

9XX35

3-pin
FORD:
BT4318D584AA

FORD

9XX36

3-pin

CHRYSLER/DODGE

9XX37

2-pin

JEEP

9XX38

5-pin
ALFA ROMEO/
FIAT/LANCIA:
60625482

ALFA ROMEO/FIAT/LANCIA

9XX39

4-pin
FORD:
F2CZ-19D594-A

FORD

9XX40

2-pin
CHEVROLET/
ISUZU/SAAB:
15144494

CHEVROLET/ISUZU/SAAB

9XX41

2-pin
CHRYSLER/
DODGE:
5290240AB

CHRYSLER/DODGE

9XX42

4-pin
LAND ROVER:
CDP5560/
JTB100220

LAND ROVER

9XX43

3-pin
MITSUBISHI:
42C15-1

MITSUBISHI

9XX44

2-pin
TOYOTA:
88645-34010

MITSUBISHI/TOYOTA

9XX46

2-pin
KIA:
GB6H-61-503

MAZDA/KIA

9XX47

3-pin
TOYOTA:
499000-7880

TOYOTA

9XX48

2-pin
HONDA:
80440-SW5-A01

HONDA

9XX49

5-pin
FIAT:
46533981

FIAT/LANCIA

NEW v.01 9XX50

2-pin
CHEVROLET:
15966454

CHEVROLET

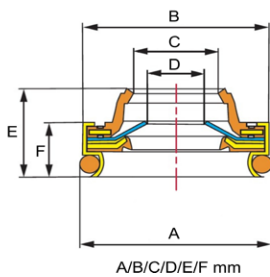

**SANDEN/DELPHI/
ZEXEL** **10XX01**

A: - B: 26,3
C: 13 D: 10,5
E: 11,25 F: 7,1

DENSO **10XX02**

A: - B: 27,23
C: 13,27 D: 9,7
E: 12,05 F: 9,53

DELPHI **10XX03**

A: - B: 31,6
C: 10,8 D: -
E: 7,7 F: -

SANDEN **10XX04**

A: 27 B: 25,83
C: 13,87 D: 9,37
E: 11,42 F: -

10XX05

A: - B: 23,48
C: 12,66 D: 10,05
E: 10,3 F: 7

 FX15/FS10

PANASONIC **10XX06**

A: 24 B: 22,84
C: 10,29 D: -
E: 15 F: -

DENSO **10XX07**

A: - B: 30,35
C: 30,35 D: 11,09
E: 15,18 F: 10

DIESEL KIKI **10XX08**

A: - B: 30,42
C: 13,75 D: 11,4
E: 14,9 F: 9,8

DELPHI **10XX09**

A: 26,09 B: 25
C: 13,45 D: 9,28
E: 11,2 F: 7,8

 V5

DENSO **10XX10**

A: - B: 26,48
C: 13,48 D: 10,1
E: 14,2 F: 9,73

SCROLL **10XX11**

A: - B: 24,32
C: 12,07 D: 8,1
E: 11,25 F: 7,13

10XX12

A: - B: 24,38
C: 12,28 D: 9,39
E: 10,16 F: 6,92

DENSO **10XX13**

A: 30,65 B: 29,9
C: 29,9 D: 11,22
E: 14,7 F: 8,81

10XX14

A: 23,62 B: 22,87
C: - D: 8,46
E: 14,53 F: -

DELPHI **10XX15**

A: - B: 31,34
C: 11,28 D: 10,44
E: 9,8 F: -

DIESEL KIKI **10XX16**

A: 30,59 B: 30
C: 10,95 D: 9,8
E: 14,14 F: -

 DKS16H

10XX17

A: - B: 24,12
C: 11,7 D: 9,12
E: 12,39 F: 7,86

10XX18

A: - B: 26,25
C: 13,29 D: 10,43
E: 12 F: 7

10XX19

A: - B: 30,04
C: 15 D: 10,12
E: 11,15 F: 6

DIESEL KIKI **10XX20**

A: 33,09 B: 31,88
C: 17,45 D: 11,14
E: 14,82 F: -

 DKS32C

SANDEN **10XX21**



A: 25,1 B: 24
C: 13,3 D: 10,3
E: 11,88 F: -

SANDEN **10XX22**



A: - B: 25
C: 12,4 D: 10,4
E: 11,3 F: 7

 PXC14

10XX23



A: 40,6 B: 39,9
C: 19,6 D: 15,1
E: 12,2 F: -

 TM31

10XX24



A: - B: 24,4
C: 11,4 D: 9,6
E: 10,9 F: 7

DENSO **10XX25**



A: - B: 24,7
C: 12,6 D: 10,5
E: 11,1 F: 7

DELPHI/HARRISON **10XX28**

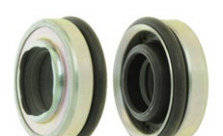

A: 31 B: 30
C: 14 D: 10,7
E: 12 F: 10

10XX26



A: 37 B: -
C: 2,5 D: -
E: 32 F: -

 V5

M13-2104

DENSO **10XX29**



A: 30,5 B: 29,5
C: 15,5 D: 10,5
E: 10 F: -

 TV12C

CALSONIC **10XK01**



A: 31,5 B: -
C: 15 D: 9,5
E: 10 F: 7,3

10XK02



A: - B: 31,7
C: 13,31 D: 10
E: 8,64 F: -

CALSONIC **10XK03**



A: - B: 31,6
C: 10,8 D: -
E: 7,7 F: -

10XK04



A: - B: 29,21
C: 15,61 D: -
E: 11,58 F: 8,18

10XK05



A: - B: 23,48
C: 12,66 D: 10,05
E: 10,05 F: 7

DENSO **10XK06**



A: 29,1 B: 26,8
C: 16,2 D: -
E: 23,5 F: 15

DENSO **10XK07**



A: - B: 30,35
C: 13,42 D: 11,09
E: 11,09 F: 10

SANDEN **10XK08**



A: 25 B: 22
C: - D: 12
E: 23 F: 15

**MATSUSHITA/
PANASONIC** **10XK09**



A: 23 B: 22
C: - D: 12
E: 23 F: 15

SANDEN **10XK10**



A: - B: 24,3
C: 11,83 D: 9,08
E: 10,3 F: 7,05

VISTEON **10XK11**



A: 24,55 B: 24
C: 12,87 D: 9,54
E: 12,05 F: -

DELPHI/HARRISON **10XK12**



A: 31,8 B: 28
C: 15 D: -
E: 25 F: 17,5

10XK13



A: 27 B: 25,83
C: 13,87 D: 9,37
E: 9,37 F: 11,42

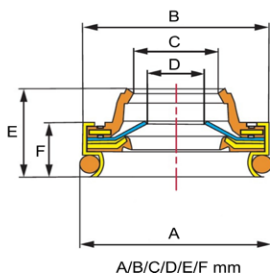

DENSO **10XK14**

A: - B: 30,35
 C: 13,42 D: 11,09
 E: 15,18 F: 10

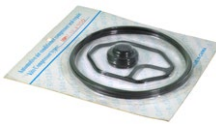

YORK **10XK15**

A: 38 B: -
 C: 21,7 D: -
 E: 13,4 F: -



YORK **10XK16**

A: 76,7 B: 39,4
 C: 21,5 D: -
 E: 18,5 F: -



DELPHI/HARRISON **10XK17**

A: 31 B: 30
 C: 14 D: 10,7
 E: 12 F: 10



SEIKO-SEIKI **10XK18**

A: 29,2 B: 27,5
 C: 13,8 D: -
 E: 25,6 F: 17,3

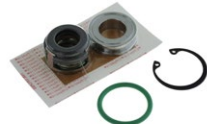

10XK19

A: 27,8 B: -
 C: 12,7 D: 9,4
 E: 10,7 F: 6,2



 **HITACHI**

DENSO **10XK20**

A: 30,5 B: 29,5
 C: 15,5 D: 10,5
 E: 10 F: -



 **TV12C**

10XK21

A: 31 B: 28
 C: 13,5 D: -
 E: 27 F: 17

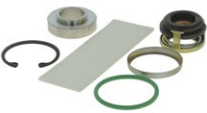

10XK22

A: - B: 30,5
 C: 13,5 D: 11
 E: 14,5 F: 10



ZEXEL **10XK23**

A: - B: 30
 C: 18,5 D: -
 E: 8 F: -



 **BERG WINGCELL/
NIHON DKV14B**

YORK **10XK24**

A: 32 B: 28
 C: 13 D: -
 E: 27 F: 17











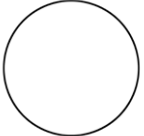

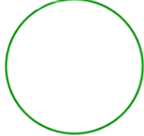

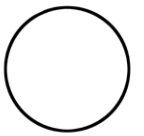

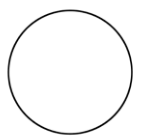













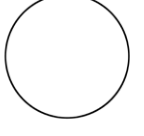

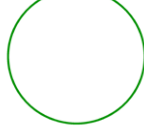

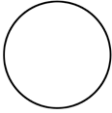

SANDEN **10XK25**

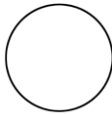
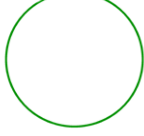
A: 27,5 B: 24,7
 C: 14 D: -
 E: 22,5 F: 14,8

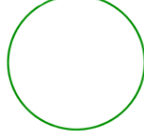

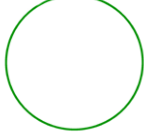
 **SD708**

DELPHI  10XX101 size: 114x2,6  V5 M13-2108	DELPHI  10XX102 size: 103x1,6  CVC M13-2115	10XX103  size: 110x3  10PA M20-2140
FORD  10XX104 size: 100x2,7  FX M12-2114	SANDEN  10XX106  PXV16 MT1082	DENSO  10XX107  7SB16C MT1081
DENSO  10XX109  10PA17C MT0185	SANDEN  10XX110 size: 115x2  SD7V16 M20-2158	MITSUBISHI  10XX111  MSC90C MT0700
SCROLL  10XX112 MT1090	CALSONIC/ DIESEL KIKI  10XX114 M30-2120	SANDEN  10XX115 size: 105x2  SD6V12 M55-2102
DENSO  10XX118  10P13/10P15 M20-2135	DELPHI  10XX119 size: 98,05x1,78  SP10	SANDEN  10XX120  PXE16 G25-3102
SEIKO-SEIKI  10XX121 size: 84x3 M35-1003	DIESEL KIKI  10XX122 size: 114x3  10PA20C M20-2159	PANASONIC  10XX123 MT0341
10XX124  size: 100x2,5  10P08E M20-1010	VISTEON/KEIHIN/ GM/ HARRISON  10XX125 size: 102x2 M65-2133	DENSO  10XX126  10P17C MT0662

MATSUSHITA/
PANASONIC

10XX127



MT1660

DENSO

10XK200



10S

G20-2010

DENSO

10XK201

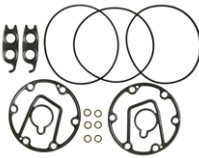

CHRYSLER C171

MT2109

SANDEN

10XK203

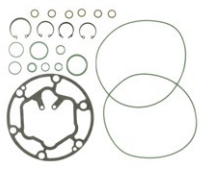

CHRYSLER SD6C17

K11-2115

FORD FS

10XK204



K12-2125

DELPHI

10XK205

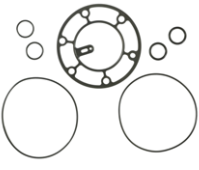

V5

K13-2020

DELPHI

10XK206

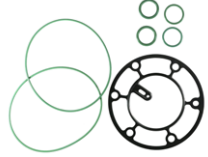

V5

K13-2120

DELPHI

10XK207

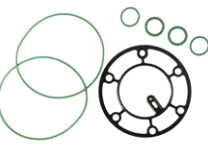

V5

K13-2121

DELPHI

10XK208

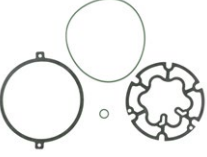

K13-2128

DENSO

10XK209

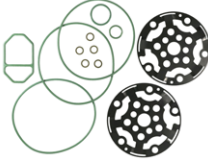

K20-2158

DENSO

10XK210



10PA17C

K20-2159

DENSO

10XK211

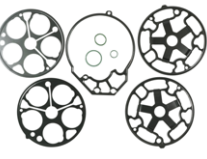

10S

K20-2161

DENSO

10XK212



10S13

K20-2170

SANDEN

10XK213



SD708/SD709/SD7H15

K25-2115

SANDEN

10XK214



SD7V16

K25-2127

SANDEN

10XK215

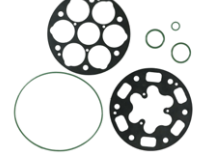

SD6V12

K25-2140

DELPHI

10XK216

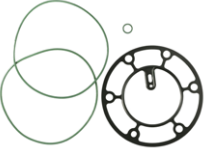

V5

K75-2100

DENSO

10XK217



7SB16

MT2195

SANDEN

10XK218



PXE16

MT2210

SANDEN

10XK219



PXE13

MT2223

DENSO

10XK220



5SE09C

MT2242

DENSO **10XK221**

5SE12C
MT2243

VISTEON **10XK222**

VS16
MT2247

DENSO **10XK223**

6SEU12
MT2360

DENSO **10XK224**

6SEU16
MT2361

DIESEL KIKI **10XK225**

DCW17
MT2372

DENSO **10XK226**

7SBU16/7SEU16
MT2359

DELPHI/HARRISON **10XK227**

MT2226

DENSO **10XK228**

10PA17C
MT2305

DELPHI/HARRISON **10XK229**

MT2198

DENSO **10XK230**

10P17C
MT2134

DENSO **10XK231**

10P17C
MT2305

DELPHI/GM/HARRISON **10XK232**

A6
MT2117

ZEXEL **10XK233**

TM13 / TM15
MT2370

DIESEL KIKI **10XK234**

DKS17CH
MT2269

MATSUSHITA/PANASONIC **10XK235**

MT2275

VISTEON **10XK236**

HS090
MT2358

DELPHI/HARRISON **10XK237**

SP10
MT2189

YORK **10XK238**

206, 209, 210
MT2080

CHRYSLER **10XK239**

RV2
MT2110

DENSO **10XK240**

TV12SC/TV14SC
MT2142

SANDEN **10XK241**

SD7V16
MT2218

DENSO **10XK242**

 10PA20
MT2308

SEIKO SEIKI **10XK243**

 SS121DV2
MT2327

DENSO **10XK244**

 10S15/17/10S
MT2361

MITSUBISHI **10XK245**

 MSC90
MT2128

SANDEN **10XK246**

 SD708 / SD709 / SD7H15
MT2144

SANDEN **10XK247**

 TRSA09/TRSE07
MT2278

DIESEL KIKI **10XK248**

 DCS17C/DCS17D
MT2225

CALSONIC **10XK249**

 DKV14D
MT2204

SCROLL **10XK250**

MT2356

SEIKO-SEIKI **10XK251**

 SEIKO-SEIKI
MT2212

BOCK **10XK252**

 BEHG WINGCELL
MT2107

DENSO **10XK253**

 10P13C / 10P15C
MT2133

YORK **10XK254**

MT2184

DENSO **10XK255**

 6CA17C
MT2365

SANDEN **10XK256**

 SD505 / SD507 / SD508
MT2143

DIESEL KIKI **10XK257**

 DKS17S
MT2315

DENSO **10XK258**

 6E171 / 6E171A
MT2137

DENSO **10XK259**

 6P134
MT2139

VISTEON **NEW 10XK261**

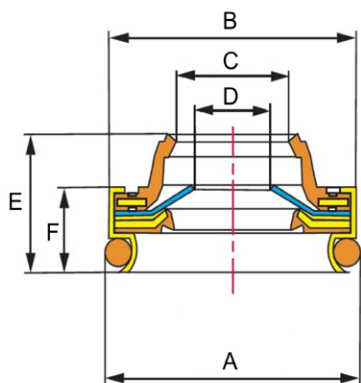

A/B/C/D/E/F mm

SEALS (shaft)

Uszczelnienia czołowe



Nr AcAuto	A	B	C	D	E	F	Application
10XK08	25	22	-	12	23	15	SANDEN - SD505/TR70/TR90/TR105
10XK09	23	22	-	12	23	15	MATUSHITA/PANASONIC - N1300 Series, N1301 Series, NL1300, Series, S1150 Series, SA1150AE4
10XX06	24	22,84	10,29	-	15	-	MATSUSHITA/PANASONIC - N1301/NL1300
10XX14	23,62	22,87	-	8,46	14,53	-	
10XK05	-	23,48	12,66	10,05	10,05	7	FORD - FS10/FX15
10XX05	-	23,48	12,66	10,05	10,3	7	FORD - FS10/FX15
10XK11	24,55	24	12,87	9,54	12,05	-	MITSUBISHI -AX105VSR/FX105V/FX80/FXA105VS/FXA105VSLR/FXA105VSR/ FXA105VSS/MS105CVS/MS90/MS90C / SANDEN—TR090/TR105/TR105VS/ TR70/TRF090/TRF105/TRS090
10XX21	25,1	24	13,3	10,3	11,88	-	
10XX17	-	24,12	11,7	9,12	12,39	7,86	SD505/TR70/TR90/TR105
10XK10	-	24,3	11,83	9,08	10,3	7,05	MITSUBISHI -AX105VSR/FX105V/FX80/FXA105VS/FXA105VSLR/FXA105VSR /FXA105VSS/MS105CVS/MS90/MS90C
10XX11	-	24,32	12,07	8,1	11,25	7,13	FORD SCROLL
10XX12	-	24,38	12,28	9,39	10,16	6,92	
10XX24	-	24,4	11,4	9,6	10,9	7	
10XX25	-	24,7	12,6	10,5	11,1	7	
10XK25	27,5	24,7	14	-	22,5	14,8	SANDEN SD708 / SD709
10XX22	-	25	12,4	10,4	11,3	7	PXE14
10XX09	26,09	25	13,45	9,28	11,2	7,8	DELPHI -V5/V7
10XK13	27	25,83	13,87	9,37	9,37	11,42	SANDEN—SD507 / SD508 / SD510 / TR80
10XX04	27	25,83	13,87	9,37	11,42	-	SANDEN - 6CA17C/7SB16 / DIESEL KIKI - DKS13CH,15,17 / GM/HARRISON - SP10 SANDEN - SD5H13/SD6V12/SD708/SD709/SD7B10/SD7H13/SD7H15/SD7V16 SEIKO- SEIKI -SS121DV2 / TAMA—TM08/TM13
10XX18	-	26,25	13,29	10,43	12	7	
10XX01	-	26,3	13	10,5	11,25	7,1	CALSONIC - CR14 / DAEWOO - V5 / DELPHI - CVC165/CVC185 / DENSO - SC06/ SCS06 DIESEL KIKI - DCW17 / SANDEN - SD5H13/SD7H15/SD7V16/SD7C16/TRSE07/ PXE13/PXE16 / SEIKO SEIKI—SS10 / TAMA - TM08HD/TM13/TM15/TM16
10XX10	-	26,48	13,48	10,1	14,2	9,73	DENSO -10S11/13/15/17
10XK06	29,1	26,8	16,2	-	23,5	15	CHRYSLER -A590/C171 / DENSO -10P08/10P13/10P15/10P17C/10PA15/10PA17/10PA1 5C 10PA17C/6E171/6P127/6P134/6P148 / FORD - FS6
10XX02	-	27,23	13,27	9,7	12,05	9,53	DENSO - 6SEU12/6SEU16/7SE16/7SEU16 / CALSONIC - CWV
10XK18	29,2	27,5	13,8	-	25,6	17,3	SEIKO-SEIKI
10XK24	32	28	13	-	27	17	YORK / TCCI
10XK21	31	28	13,5	-	27	17	HARRISON A6/R4
10XK12	31,8	28	15	-	25	17,5	HARRISON A6/R4
10XK04	-	29,21	15,61	-	11,58	8,18	
10XK20	30,5	29,5	15,5	10,5	10	-	DENSO- TV12C/TV12SC/TV14SC
10XX29	30,5	29,5	15,5	10,5	10	-	DENSO- TV12C/TV12SC/TV14SC
10XX13	30,65	29,9	29,9	11,22	14,7	8,81	DENSO -10PA15/10PA17
10XX16	30,59	30	10,95	9,8	14,14	-	
10XK17	31	30	14	10,7	12	10	HARRISON
10XX28	31	30	14	10,7	12	10	HARRISON
10XK23	-	30	18,5	-	8	-	BEHR - WINGCELL, NIHON DKV14B
10XX19	-	30,04	15	10,12	11,15	6	
10XK07	-	30,35	13,42	11,09	11,09	10	DENSO-10PA15/10PA17/10PA20
10XK14	-	30,35	13,42	11,09	15,18	10	DENSO-10PA15/10PA17/10PA20
10XX07	-	30,35	30,35	11,09	15,18	10	DENSO -10PA15/10PA17/10PA20
10XX08	-	30,42	13,75	11,4	14,9	9,8	DIESEL KIKI -DKV116/DKV14C/DKV14D/DKV14G
10XK22	-	30,5	13,5	11	14,5	10	DENSO 10PA17J
10XX15	-	31,34	11,28	10,44	9,8	-	
10XX03	-	31,6	10,8	-	7,7	-	CALSONIC - V5-15 / GM/HARRISON - DA6/HR6/HR6HE/HD6/HT6/R4/V5
10XK03	-	31,6	10,8	-	7,7	-	Calsonic V5, GM/Harrison V5, R4, LTR4, DA6, HD6, HR6, HR6HE, HT6 H-Series
10XK02	-	31,7	13,31	10	8,64	-	
10XX20	33,09	31,88	17,45	11,14	14,82	-	
10XK16	76,7	39,4	21,5	-	18,5	-	YORK
10XX23	40,6	39,9	19,6	15,1	12,2	-	TM31
10XX26	37	-	2,5	-	32	-	Calsonic V5-15C, V5-15F, V5-15G, Diesel Kiki DKS16H (R12) GM / Harrison DA6, HR6, HR6HE, V5, V5, A6, R4, HD6, HT6, HU6
10XK19	27,8	-	12,7	9,4	10,7	6,2	HITACHI
10XK01	31,5	-	15	9,5	10	7,3	DELPHI V5
10XK15	38	-	21,7	-	13,4	-	

SANDEN

11SD01



7/8" - 3/4"
JD TYPE
SD7H15

SANDEN

11SD02



7/8" - 3/4"
KC TYPE
SD7H15

SANDEN

11SD03



7/8" - 3/4"
SD TYPE
SD7H15

SANDEN

11SD04



1" - 1"
MD TYPE
SD7H15

SANDEN

11SD05



1" - 1"
CB TYPE
SD7H15

SANDEN

11SD06



17,6mm 14,5mm
WV TYPE
SD7H15

SANDEN

11SD07



7/8" - 3/4"
FG TYPE
SD5H14

SANDEN

11SD08



QC TYPE
SD7H15

ZEXEL

11ZX01



7/8" - 3/4"
COMPRESSOR
FITTING
HORIZONTAL
TM

ZEXEL

11ZX02



7/8" - 3/4"
COMPRESSOR
FITTING
VERTICAL
TM

ZEXEL

11ZX03



1" - 1"
COMPRESSOR
FITTING
HORIZONTAL
TM

ZEXEL

11ZX04



1" - 1"
COMPRESSOR
FITTING
VERTICAL
TM

12XX01



8mm
90°
Thread internal
Thick
-
Metal

FITTINGS

12XX02



8mm
-
-
Thick
-
Metal

HOSE HOLDER

12XX03



10mm
-
-
Thick
-
Metal

HOSE HOLDER

12XX04



10mm
90°
Thread internal
Thick
-
Metal

FITTINGS

12XX05



6mm
-
-
Thin
-
Metal

HOSE HOLDER

12XX06

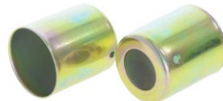

12mm
-
-
Thick
-
Metal

HOSE HOLDER

12XX07

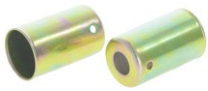

6mm
-
-
Thick
-
Metal

HOSE HOLDER

12XX08



12mm
-
-
Thin
-
Metal

HOSE HOLDER

12XX09



10mm
-
-
Thin
-
Metal

HOSE HOLDER

12XX10



8mm
-
-
Thin
-
Metal

HOSE HOLDER

12XX11



6mm
Straight
-
Thick
-
Aluminium

FITTINGS

12XX12



10mm
Straight
-
Thick
-
Aluminium

FITTINGS

12XX13



12mm
Straight
-
Thick
-
Aluminium

FITTINGS

12XX14



8mm
Straight
-
Thick
-
Aluminium

FITTINGS

12XX15



8mm
Straight
-
Universal
-
Aluminium

FITTINGS

12XX16



8mm
Straight
-
Universal
-
Aluminium

FITTINGS

12XX17



6mm
Straight
-
Universal
-
Aluminium

FITTINGS

12XX18



10mm
Straight
-
Universal
+ L
Aluminium

FITTINGS

12XX19



6mm
Straight
-
Universal
+ H
Aluminium

FITTINGS

12XX20



10mm
Straight
-
Universal
-
Aluminium

FITTINGS

12XX21



12mm
Straight
-
Universal
-
Aluminium

FITTINGS

 <p>12XX22 6mm Straight solder internal Universal - Aluminium</p> <p>FITTINGS</p>	 <p>12XX23 8mm Straight solder internal Universal - Aluminium</p> <p>FITTINGS</p>	 <p>12XX24 10mm Straight solder internal Universal - Aluminium</p> <p>FITTINGS</p>
 <p>12XX25 12mm Straight solder internal Universal - Aluminium</p> <p>FITTINGS</p>	 <p>12XX26 6mm Straight solder external Universal - Aluminium</p> <p>FITTINGS</p>	 <p>12XX27 8mm Straight solder external Universal - Aluminium</p> <p>FITTINGS</p>
 <p>12XX28 10mm Straight solder external Universal - Aluminium</p> <p>FITTINGS</p>	 <p>12XX29 12mm Straight solder external Universal - Aluminium</p> <p>FITTINGS</p>	 <p>12XX30 6mm Straight Thread internal Universal - Aluminium</p> <p>FITTINGS</p>
 <p>12XX31 8mm Straight Thread internal Universal - Aluminium</p> <p>FITTINGS</p>	 <p>12XX32 8mm Straight Thread internal Universal - Aluminium</p> <p>FITTINGS</p>	 <p>12XX33 10mm Straight Thread internal Universal - Aluminium</p> <p>FITTINGS</p>
 <p>12XX34 10mm Straight Thread internal Universal - Aluminium</p> <p>FITTINGS</p>	 <p>12XX35 12mm Straight Thread internal Universal - Metal</p> <p>FITTINGS</p>	 <p>12XX36 6mm 45° Thread internal Universal - Aluminium</p> <p>FITTINGS</p>
 <p>12XX37 8mm 45° Thread internal Universal - Aluminium</p> <p>FITTINGS</p>	 <p>12XX38 10mm 45° Thread internal Universal - Aluminium</p> <p>FITTINGS</p>	 <p>12XX39 12mm 45° Thread internal Universal - Aluminium</p> <p>FITTINGS</p>
 <p>12XX40 6mm 90° Thread internal Universal - Metal</p> <p>FITTINGS</p>	 <p>12XX41 8mm 90° Thread internal Universal - Metal</p> <p>FITTINGS</p>	 <p>12XX42 8mm 90° Thread internal Universal + Universal Aluminium</p> <p>FITTINGS</p>

12XX43



10mm
90°
Thread internal
Universal
-
Metal

FITTINGS

12XX44



10mm
90°
Thread internal
Universal
+ L
Metal

FITTINGS

12XX45



6mm
45°
Thread external
Universal
-
Aluminium

FITTINGS

12XX46



8mm
Straight
Thread external
Universal
-
Aluminium

FITTINGS

12XX47



10mm
Straight
Thread external
Universal
-
Aluminium

FITTINGS

12XX48



6mm
45°
Thread external
Universal
-
Aluminium

FITTINGS

12XX49



8mm
45°
Thread external
Universal
-
Aluminium

FITTINGS

12XX50



10mm
45°
Thread external
Universal
-
Aluminium

FITTINGS

12XX51



6mm
90°
Thread external
Universal
-
Aluminium

FITTINGS

12XX52



8mm
90°
Thread external
Universal
-
Aluminium

FITTINGS

12XX53



6mm
90°
Thread internal
Universal
-
Aluminium

FITTINGS

12XX54



-
G6
Thin
5/16"
-

HOSE

12XX55



-
G8
Thin
13/32"
-

HOSE

12XX56



-
G10
Thin
1/2"
-

HOSE

12XX57



-
G12
Thin
5/8"
-

HOSE



BENDIKS.PL

ALTERNATORS & STARTERS

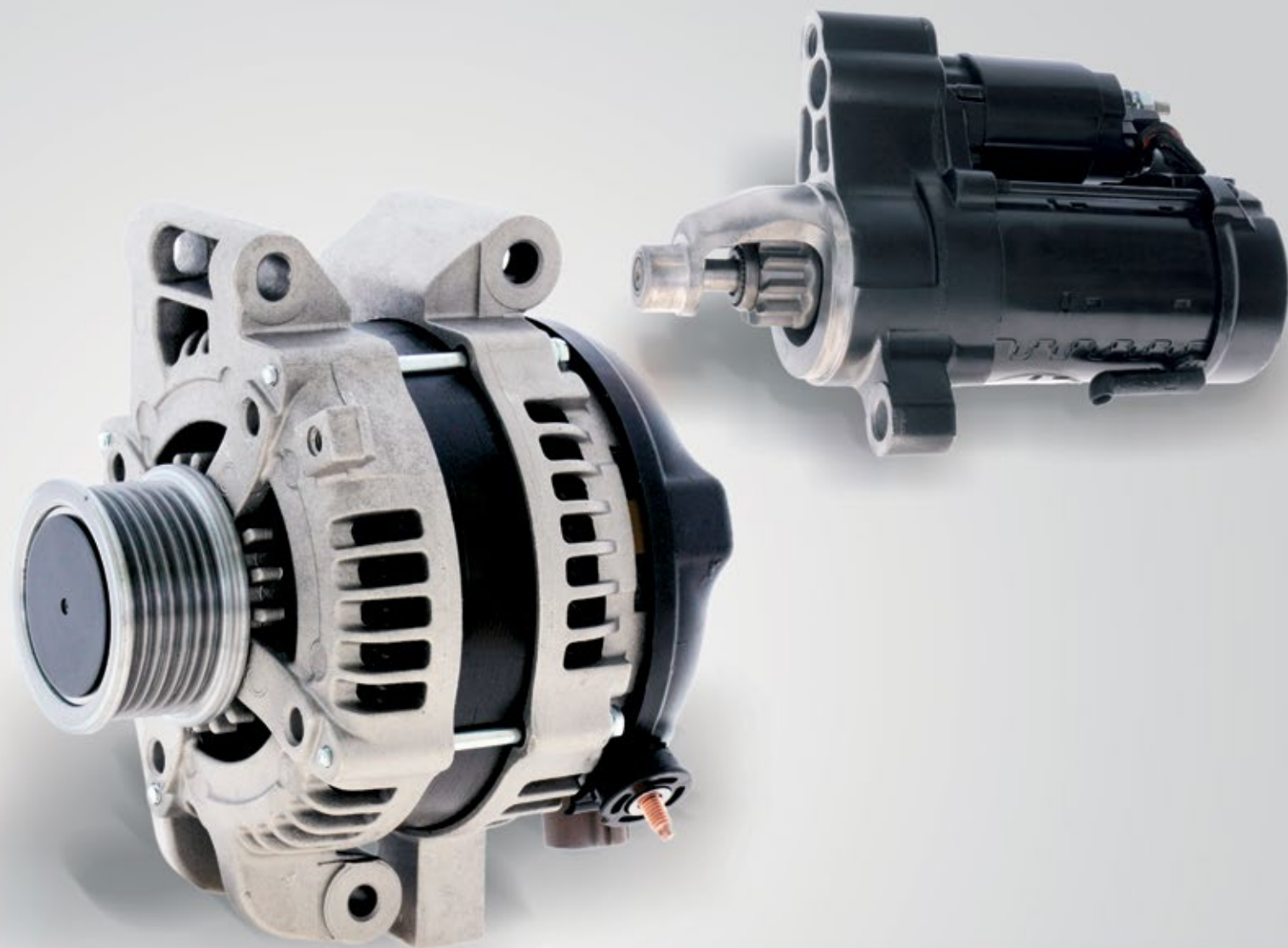

ALTERNATORS

STARTERS

Spare parts for alternators & starters

Części zamienne do alternatorów i rozruszników

Remanufacturing alternators & starters

Regeneracja alternatorów i rozruszników



BENDIKS.PL
ALTERNATORS & STARTERS

05-092 Łomianki, ul. Kolejowa 117a
tel.+ 48 22 768 72 00 mail: bendiks@bendiks.pl
www.bendiks.pl

SHOP.ACAUTO.PL

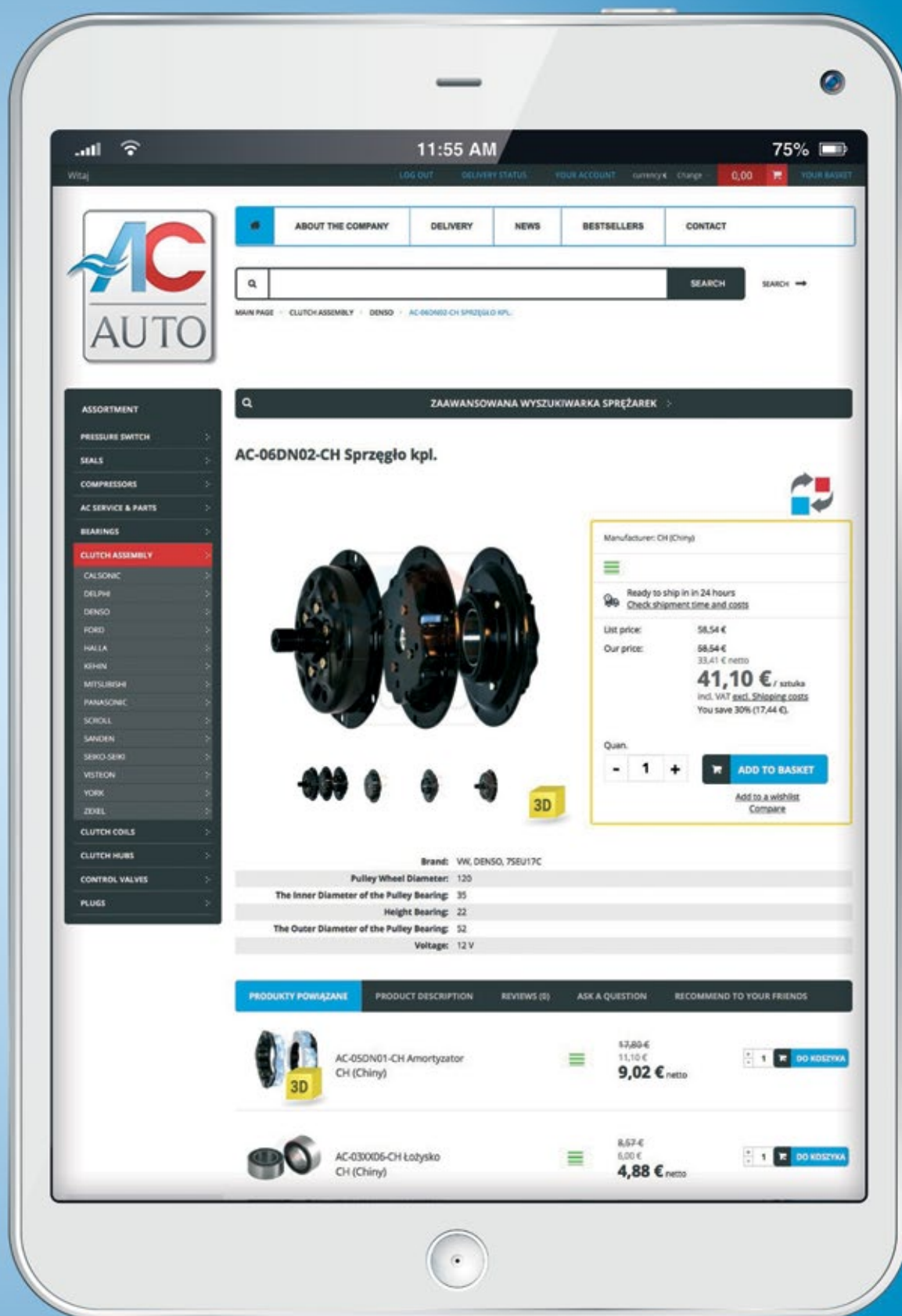



Driven by Improvement

www.acauto.pl

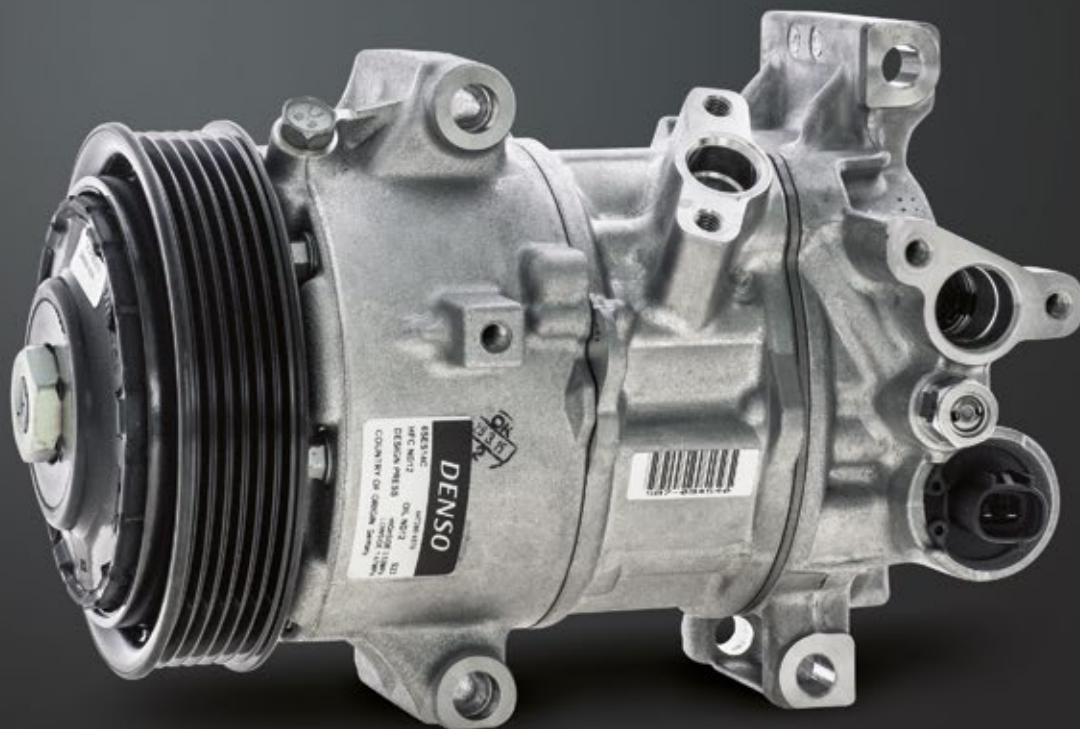

DISTRIBUTOR

www.acauto.pl

MEMBER OF
N! | NEXUS
A PROGRESSIVE AUTOMOTIVE COMMUNITY
CENTRAL EUROPE



*Driven
by Improvement*

DISTRIBUTOR



ACAUTO S.C.



Ul. Kolejowa 117 05-092 Łomianki, Poland



tel. +48 22 751 33 54, +48 795 335 900, +48 22 873 83 03



info@acauto.pl



www.acauto.pl